

[Type here]



Updated February 2024

**Australian National Budgerigar Council (ANBC) Inc.**  
***The Standard (2003) - Electronic Version***

Hard copies of this Standard will be available to Financial Members through State/Zone Secretary's whilst stocks last.

Pages containing graphics, including the cover in the Hard copy, are considered to be intellectual property of the Australian National Budgerigar Council Incorporated (ANBC)

*The Standard* was first printed in 1990. It was re-written then printed in loose leaf form in 2003 following the decision by the ANBC to redevelop the Pictorials.

The master copy is held by the ANBC Colour and Standards National Co-ordinator. It was duly endorsed by the National Secretary on behalf of the ANBC and took effect on the 1st of January 2004.

Amendments, once adopted, are included in the electronic copy however amendments approved by Council are not formalized until *The Standard* is updated.

**AMENDMENT CERTIFICATE**

<b>Amendment</b>			<b>Effected</b>	
<b>NO</b>	<b>Date</b>	<b>Section/Page</b>	<b>Signature</b>	<b>Date</b>
1/08	31 Oct 2008	Replace Pages, 4/5, 16/17, 24/25, 32/33, 34/35, 41/42 and 45/46	Bob Bourke	31 Oct 2008
1/09	14 Dec 2009	Replace Page 45/46	Bob Bourke	14 Dec 2009
1/10	5 Dec 2010	Replace Pages 16/17, 18/19, 22/23 to 38/39.	Bob Bourke	12 Dec 2010
1/11	20 Nov 2011	Replace page 16/17, 43/44	Bob Bourke	20 Nov 2011
1/12	20 Nov 2012	Replacement of multiple pages including Pied review and Yellow Faced Blue changes as a series (colour)	Peter Glassenbury	20 Nov 2012
1/13	10 Nov 2013	Replacement of multiple pages including Grey factor in Black Eyed Self Group, Amend name change to Dilute and Dilute wording, revert to 12mm perches, accept additional show cage stopper, renaming Yellow Faced varieties, acceptance of mutation Australian White Cap and nominal wording amendments.	Peter Glassenbury	10 Nov 2013
1/14	30 Sept 2014	Amended Crested Standard included. Removal of Customwood from cage making material. Changes to P & D clauses for missing flights.	Peter Glassenbury	30 Sept 2014

1/16	20 July 2016	<p>Amended Cheek Patches Darkwing Cinnamon.</p> <p>Interim Standard for Australian White Cap included in E Standard (further review required after minimum of two years)</p> <p>Full review of Yellow Faced group addressed accepting this group as a colour.</p> <p>Changes to P &amp; D also attended for the Yellow Faced Group.</p> <p>Index updated to reflect changes.</p>	Peter Glassenbury	20 July 2016
1/17	20 June 2017	<p>Amend Matrix to include Dark Eyed Clear and include description in general section of Standard.</p> <p>Amend P &amp; D Clauses as per ANBC Judges Minutes.</p> <p>Remove word Interim from Australian White Cap description.</p> <p>Amend Description of Perfection regarding Head features.</p> <p>Insert Fallow in Dutch Dominant Pied Group.</p>	Peter Glassenbury	10 August 2017
6/19	10 June 2019	<p>Amendments numbers to Matrix section for Pies and AOSV updated.</p> <p>Show Cage Perch size amended to revert to 12mm with a provision.</p> <p>Amended coating requirements for show cage fronts.</p> <p>Amended painting requirements for Show Cages.</p> <p>Removed page reference to matrix throughout document given continually changing document.</p> <p>Remove historical data re ANBC and Show and History. Now to be recorded on Web Site.</p> <p>Attend changes to P &amp; D Clause regarding Flecked birds and delete Barring clause for Recessive Pies.</p> <p>Attended changes to Australian Golden Face to reflect Disqualification thereof.</p> <p>Amend Eye Colour for Fallow for consistency.</p> <p>Include Ownership Clause under P &amp; D.</p>	Peter Glassenbury	20 June 2019
6/21	3 June 2021	<p>Updated of Black Eyed Self with removal of Grey Factor. Effective January 2022</p>	Peter Glassenbury	3 June 2021

7/22		Inclusion of Australian White Cap as a class in the Matrix. Transfer of AWC from AOSV to a Standard variety. Amended AWC wording as approved in C & S 2022 minutes. Finalise missed Black Eyed Self 2021 amendment as to points allocation page 23.	Peter Glassenbury	
7/23	24 June 2023	Allocation of Points Heading addressed from 2022 page 23.	Peter Glassenbury	24 <sup>th</sup> June 2023
2/24	20 <sup>th</sup> February 2024	Adoption of the wording Melanistic Spangle Amended P & D pictorial of Flecking Adoption of Rainbow Standard	Peter Glassenbury	20 <sup>th</sup> February 2024

## Table of Contents

AMENDMENT CERTIFICATE .....	2
INTRODUCTION .....	7
THE WILD BUDGERIGAR (Ornithological Notes).....	8
DISTRIBUTION AND HABITAT .....	8
DESCRIPTION OF THE WILD BUDGERIGAR .....	9
NESTING HABITS AND FEEDING.....	9
THE WORLD STARTS BREEDING - EVOLUTION OF COLOUR VARIETIES.....	10
GREEN .....	10
YELLOW .....	10
SKY BLUE.....	10
DARK GREEN .....	11
OLIVE.....	11
COBALT.....	11
MAUVE .....	11
WHITE.....	11
INO .....	11
GREY.....	11
GREYWING.....	12

CLEARWING .....	12
FALLOW .....	12
OPALINE.....	13
CINNAMONWING .....	13
YELLOW FACED BLUE .....	13
VIOLET .....	14
PIED.....	14
DARK EYED CLEAR .....	15
LACEWING .....	15
SPANGLE .....	15
CLEARBODY.....	15
DARKWING .....	16
CRESTED .....	16
AUSTRALIAN WHITE CAP .....	16
PICTORIAL TREND OF STANDARDS .....	18
MAIN FEATURES OF A BUDGERIGAR .....	19
THE IDEAL.....	20
IDEAL HEN AND COCK - BUST .....	21
DESCRIPTION OF PERFECTION.....	22
SCALE OF POINTS.....	23
USE OF THIS STANDARD - MATRIX.....	24
VARIETY STANDARDS .....	25
NORMAL SERIES: (GREEN, BLUE and YELLOW FACED BLUE).....	25
BLACK EYED SELF COLOUR: .....	27
DILUTE:.....	28
RED EYED SELF COLOUR: .....	29
DARK EYED CLEAR: .....	30
CLEARWING: .....	30
GREYWING:.....	31
CINNAMONWING: .....	32
SPANGLE DOUBLE FACTOR:.....	32
OPALINE: .....	33

CLEARBODY: .....	34
LACEWING: .....	34
FALLOW: .....	35
SPANGLE:.....	36
PIED GROUPS.....	37
DOMINANT PIED:.....	37
DUTCH DOMINANT PIED:.....	38
RECESSIVE PIED.....	39
AUSTRALIAN WHITE CAP SINGLE FACTOR.....	39
AUSTRALIAN WHITE CAP DOUBLE FACTOR.....	40
CRESTED: .....	41
OTHER VARIETIES and PHENOTYPE VARIANTS.....	43
OTHER VARIETIES .....	43
SADDLEBACK:.....	43
DARKWING .....	44
PHENOTYPE VARIANTS.....	45
BANDED DOMINANT PIED:.....	45
CLEARFLIGHTED DOMINANT PIED: .....	46
PAIRS, TEAMS AND COLLECTIONS:.....	48
BUDGERIGAR PENALTY AND DISQUALIFICATION CLAUSES FOR GUIDANCE OF ANBC JUDGES AND EXHIBITORS .....	50
SPECIFICATION OF THE STANDARD SHOWCAGE.....	54

## INTRODUCTION

*The Standard is published for the guidance of member bodies of the Australian National Budgerigar Council Inc. (ANBC) and to provide the basis for judging entries at any event staged by the ANBC*

*The 1990 issue of The Standard represented a major step forward in the exhibition budgerigar hobby in Australia. Previously divergent concepts of the ideal exhibition budgerigar were brought together in that publication. The description of standard colours and varieties, the grouping of compound varieties and the pictorial representation of markings and form presented a national concept of ideals.*

*The Standard has been developed with due recognition of guidelines adopted in other countries for this international hobby. It set breeders' goals for the future by being a measure for competition.*

*The pictorial from which the model was created for the first National Standard was painted by Robyn Thomas. The models were created by Mrs Jane McBurnie and were painted and photographed by Mr Peter Slater. Their contributions to that standard are gratefully acknowledged.*

*Following an ANBC decision to develop more realistic pictorials and then rewrite The Standard, a working group made up of the ANBC Colour and Standards Committee undertook this demanding task. Mr Roy Aplin a world-renowned Artist and Budgerigar Judge from the UK was commissioned to draw and paint the pictorials for use in this rewrite. Mr Rob Hugo (Secretary of the Crested Club of Australia) undertook the task of updating the pictorials for Crested. Their contribution is gratefully acknowledged.*

*The ANBC acknowledges the significant effort by the National Colour and Standards Committee in the formulation of the rewrite of The Standard. Above all, the Council acknowledges the spirit of co-operation in which the member bodies worked together to develop this standard.*

*Authority to reproduce this document in whole or part must be obtained in writing from the Secretary of the Australian National Budgerigar Council*

## THE WILD BUDGERIGAR (Ornithological Notes)

### *Melopsittacus undulatus*

This beautiful little parakeet, possibly the best known and most popular bird bred in the world today, is a native of Australia. It has had a variety of names; Undulated Parakeet, Shell Parrot, Grass Parakeet, Zebra Parrot, Warbling Grass Parrot, Scallop Parrot and Canary Parrot, all of which, fortunately, have been discarded in favour of the original native name pronounced “budgerigar”. Like so many of these aboriginal names there are many different ways of spelling and pronouncing this word. Thus, we have Budgerigar, Boodgereegar and Budgerygah.

Referring to the meaning of the aboriginal name “budgerigar” the usual definition is “good bird”, however, it can be stated on reliable authority that the name means “good food”. Two extracts support this. In *Budgerigars in the Bush and Aviary* by Neville Cayley, Percy Peir is quoted as saying that the first part of the word, pronounced “boodgeree” meant “good”, and the later part, “gar”, denoted “food” or “to eat”. He further went on to say that the aboriginal youth were taught to locate the whereabouts of food supplies, including the breeding ground of the Budgerigar. When the young birds were about in the fledgling stage, every log and sprout was raked and probed with sticks and the young were dragged out. These were quickly roasted and the juicy morsels eagerly devoured. More recently the “Daily Telegraph” of March 10th, 1958, published an account by Dr. Donald Thompson, Associate Professor of Anthropology at Melbourne University, of his time with the little known Bindibu tribe of desert aborigines. He wrote “Many of the flocks of pigeons and parrots, especially of the Kilkindjarri, the Budgerigar, come to drink as the waters dry up at the remaining rock holes and wells, or to feed on the seeding *Spinifex* towards evening. And when good kills have been made with throwing sticks, these birds are brought in armfuls by the hunters, helped eagerly by the children, especially little boys who watch a flock keenly as it circles low within range and rush to pick up the dead or wounded birds brought down by the throwing sticks. The birds were thrown onto the ashes of the small cooking fires and the feathers singed off. The whole of the bodies were eaten, including the bones, even to the skull and brains. I cannot say that the people always ate almost the entire skeleton of these small parrots, but at this time they were hungry for Kuk'a - for animal protein”.

## DISTRIBUTION AND HABITAT

Budgerigars are widespread in mainland Australia - through the interior of Queensland, New South Wales, South Australia, North Western Australia, Central Australia and West Australia, but absent in Tasmania. Usually flocks inhabit the open inland country, chiefly in areas interspersed with belts of timber and isolated patches of scrub. Being a nomadic species, it usually appears in a district after an abundant rainfall, and, although its usual breeding season in Eastern Australia is in the spring and early summer months, it will lay after heavy rains, irrespective of season. It may appear in a district for one or more seasons and then be absent again for many years.



## DESCRIPTION OF THE WILD BUDGERIGAR

The following description of the wild bird was set out in *Budgerigars in Bush and Aviary* by Neville Cayley.

“*Adult male*:-General colour above greenish-yellow, with, except on the upper wing-coverts, black transverse bars becoming broader on the scapulars - those on the upper wing coverts are dark brown and more crescent shaped in form; outer webs of quills greenish blue, dark brown on the inner, with a whitish band through the middle of the inner webs of the primaries, the outer webs of the secondaries crossed near their base by a pale green band, the inner webs with a broader yellow band; lower back, rump and upper tail-coverts grass-green, the latter tinged with blue; central pair of tail-feathers dark blue, with a greenish-blue tinge on the outer margins the remainder greenish-blue crossed with an oblique yellow band; forehead and crown of the head straw yellow; sides of face and ear coverts yellow, with narrow transverse black bars; lores, fore-part of cheeks, chin, and throat, rich yellow; on the lower cheeks a band of rich deep blue confluent spots (these spots appear violet in some lights), encircling the throat six rounded black spots, three on each side, the uppermost being partly obscured by the violet cheek-patches; remainder of the under surface, the under wing-coverts, and under tail-coverts, rich grass-green, bill greyish yellow with a bluish shade at the base; cere of the bill blue, becoming duller in colour during the non-breeding season; legs and feet fleshy grey; iris pale yellow, ring around the eye blue.

Total length in the flesh 7 ½ inches, wing 4, tail 4 1/2, bill 0.5, tarsus 0.5.

*Adult female*:-similar in plumage to the adult male, but the violet cheek-patches and black throat spots are generally smaller, and the cere of the bill is brown or greyish brown according to the season of the year.”

## NESTING HABITS AND FEEDING

The noted naturalist Gould made an early study of the Budgerigar. In *Birds of Australia* he says, “On arriving at Brezi, to the north of the Liverpool plains, in the beginning of December, I found myself surrounded by numbers [of budgerigars], breeding in all the hollow spouts of the large Eucalypti bordering the Mokai. The breeding season is at its height in December, and by the end of the month the young are generally capable of providing for themselves. They then assemble in vast flights, preparatory to their great migratory movement. The eggs are three or four in number, pure white, nine lines long by seven lines in diameter and are deposited in the holes and spouts of the gum trees. In a state of nature they feed exclusively upon grass seeds, with which their crops are always found crammed”.

Dr. Karl Russ in his book *The Budgerigar* writes - “The remarkable shape of the mallee is particularly favourable for the purpose of nesting. About eight stems grow out of the same roots to a height of about 12m with white barks and scanty tops. Every hollow trunk, every knot hole, in case of necessity even every suitable cavern in the roots is used for nesting, often by two or three couples together. The ripe seeds of grass are perfectly suited to feeding the young”.

Dr. W. MacGillivray, referring to a trip made into western New South Wales, wrote - “When we arrived at Wyalla Lake they were choosing their nesting sites in the dead timber in the Lake. Here they showed a decided preference for nesting in dead stumps and trees standing around the box flats rather than green timber. The hollows chosen were usually six inches to one foot in depth, with an

entrance about one and a half to two inches in diameter, the eggs, four or five in number, resting on the earthy material on the bottom.

Although multitudes of birds are destroyed each year by bushfires, heat waves, droughts and storms, the wild budgerigar is in no danger of becoming rare, and it should always continue to be known throughout the world, just as the Emu and Kangaroo, as a true Australian.

## **THE WORLD STARTS BREEDING - EVOLUTION OF COLOUR VARIETIES**

### ***GREEN***

The first recorded description of the natural green Budgerigar from which all other colours have evolved was by Shaw in the *Naturalists Miscellany*, 1789-1813, and the *Zoology of New Holland*, 1794. The specimen used by Shaw for the description and figure of this beautiful little parrot was collected by an early colonist somewhere in the vicinity of Parramatta, New South Wales. Shaw used the name *Psittacus undulatus*, but it was Gould who adopted the generic name *Melopsittacus*.

Gould introduced the first living pair into England in 1840, and at the same time published the first description of their habits in *The Birds of Australia*, 1840-8. He mentions that they were first called by the colonists "Canary Birds".

The Budgerigar was first bred in captivity by Countess Von Schwerin in Berlin in 1855, and some years afterwards "farming" birds by hundreds of thousands was established in many parts of Europe. In addition, enormous numbers were trapped in Australia and exported to all parts of the world until the Australian Government banned this trade.

### ***YELLOW***

This colour is a mutation, probably the first, of the natural green. It has been observed in very small numbers in wild flocks. Such specimens all had a strong suffusion of green.

When examples appeared in captivity about 1870 or soon after, German and Belgian breeders concentrated on the improvement of colour by careful selection.

It is recorded that they were bred in England in 1884 by a Mr. Joseph Abrahams from yellows imported from Belgium, but it was not until about 1900 that the first yellows appeared in Australia. These were brought out from England for Mr. C. H. A. Lienau, of Adelaide, South Australia.

### ***SKY BLUE***

Blue birds first appeared in Belgium in 1878, but disappeared soon after. The mutation reappeared again at Le Mans, and was first exhibited at the Horticultural Hall London, in 1910, and at the Crystal Palace in 1911, causing a great sensation at the time. These birds were believed to have been bred from stock owned by a Dutch breeder somewhere about 1885.

The first blue budgerigars were brought to Australia by Joseph Ellis for the Taronga Park Zoo about 1918. They were very washy in appearance and turned out failures. In 1920 another fancier

brought out five pairs. These were bred from and the progeny were distributed to other States and established. Mr Frank Buckle also imported some about 1923.

### ***DARK GREEN***

There is no record of its first appearance but it was claimed by several English importers to have been included in fractional numbers among batches of wild green imported birds - variously estimated to have been one in 10,000 or 20,000. A French breeder, M. Blanchard first observed the Dark Green in the summer of 1915.

### ***OLIVE***

The boom which the blue budgerigar created also created a corresponding interest in other colours, and when the Dark Green appeared the Olive quickly followed. These appeared in Europe in 1916 just a few months after the Dark Green. The Olive was introduced into England from France by J.D. Hamlyn in 1918. Mr. C.H.A. Lienau of South Australia imported some from England in 1918, and appears to have been the first to breed them in Australia.

### ***COBALT***

The Cobalt appears to have been produced during the development of the Dark Green and Olive. It is recorded that they were bred in France by Mr G. Hedges, when in charge of the collection of Mme. Lecallier during 1923. Mr Frank Buckle imported them into Australia also about this time.

### ***MAUVE***

The Mauves appeared in 1924, and were presumably bred by mating two Cobalt's together.

### ***WHITE***

The First Whites occurred simultaneously both in England and France during 1920 and in both cases were bred from blues that had yellow ancestry.

### ***INO***

#### **Lutino**

This mutation was reported several times during the latter half of the nineteenth century, but perhaps due to lack of necessary knowledge of propagation, was lost. However, it appeared again, simultaneously in England, Europe and Australia during 1932/36 and was firmly established.

#### **Albino**

The Albino mutation appeared at about the same time as the Cinnamonwing. They were established in Europe and Australia at almost the same time. The factor suppresses all colours (except yellow) so that the birds in the blue series are pure white and have the characteristic pink eyes.

### ***GREY***

Mrs. S. Harrison of Murrumbena, Victoria, was the first person to recognise the Grey variety in a bird (pedigree unknown) obtained from a dealer in 1935. The variety was established, and in a

short time Mrs. Harrison had Greys in several shades, light, medium and dark. Apart from the grey body a particular feature is the denser black of the tail and wing markings.

Another Grey mutation evolved in England about the same time, but it proved to be genetically different although very similar visually. Whereas the Australian Grey is dominant, the English Grey was recessive. It is not known whether this mutation still survives.

The grey factor when added to the green series combines to produce the now very popular Grey Greens. These, like the Greys, appear in three shades, light, medium and dark.

### ***GREYWING***

Greywings first appeared in England during the early 1920's, although it is on record that Greywing Greens, then known as apple greens, existed in Germany and Belgium as far back as 1875. Greywing greens appeared under various names (Jades, May or Apple) from about 1920 to 1925. In 1928 the first Greywing Skyblue (known as a Pearl) was exhibited by a Mr Hedges. Cobalt Greywings appeared about the same time, and Mauves about 1931. In a few years, they were firmly established in Australia.

In the 1930s, Greywings were produced with a much deeper body colour than was previously known. These were referred to as "full body coloured greywings". They are now regarded by some Australian fanciers as the perfect Greywing. The older variety with its 50% body colour is not favoured.

### ***CLEARWING***

During the 1930's an outstanding mutation appeared in Australia. It was bred in both Green and Blue form and was called "Clearwing". The first Clearwing appeared in the aviaries of Mr Harold Pier of Sydney.

Mr. J. Catts of Carlingford, New South Wales, was possibly the fancier that established this mutation in all the colour varieties, and this was carried on by Harley Yardley of Fivedock, New South Wales. Until his untimely death in 1957 he had developed his Clearwings to such an outstanding degree that they were almost unbeatable on the show bench.

Those fanciers, both in Australia and from overseas, who had the pleasure of viewing the Yardley stud at its peak will never forget the magnificent depth of colour and contrast in Clearwings, the like of which may never be seen again in the fancy.

### ***FALLOW***

The Fallow, as many other mutations had done, appeared about the same time in Australia and Europe, but it is recorded that the first Fallow mutation evolved and was established in the aviaries of Mr O'Brien, of Newtown, Sydney, during the early part of 1930. In Europe, the first Fallow was reported in Germany about 1934, and from the description of the two mutations it would appear that they were not identical.

Another variation of the Fallow appeared in England, which at the time was thought to be the same as the Australian mutation, but later comparison showed that they were not quite identical, genetically and to a lesser extent visually so. The major difference visually is the colour of the eye.

Whereas the English Fallow has a red eye and no iris ring, the Australian mutation has an extremely deep coloured red eye with an iris ring.

The word “fallow” was coined in Switzerland, and means untilled or undeveloped. It was never intended to mean the colour of the bird, but that the pigment was untilled and undeveloped.

### ***OPALINE***

Among the thousands of wild budgerigars delivered by trappers to the Adelaide markets in 1933, there was discovered the first Australian Opaline, a Light Green hen in baby plumage. She passed into the hands of Mr S. E. Terrill of Adelaide, South Australia, and this prominent breeder established the Opaline factor in most of the normal varieties of that time.

During 1934 the first British Opaline mutant appeared in the aviaries of Mr. A. Brown of Kilmarnock. This “Pied” hen, as she was then termed, was purchased by Mrs. Ashby, of Ayr, and paired to a Light Green cock. This mating produced only normals, but during the next season Opalines were bred by mating the original mutant back to her son. The variety, “marbled” as it had now come to be known, was fixed, and it proved to be sex-linked.

Mr. Terrill had named this new mutation “Opaline”, a name that was accepted by the budgerigar fancy throughout the world when it was found that the English mutation was identical in all respects to that established in Australia.

### ***CINNAMONWING***

The Cinnamonwing variety appeared in Australia and England almost simultaneously. Germany also reported the production of them some little time after. Although the cinnamon factor was apparently in existence some years earlier, it was not identified until about 1934.

The first Cinnamonwings were bred in Australia by a lady fancier from Adelaide, South Australia, in about 1933. The lady, whose identity is unknown, was not impressed by the appearance of the birds and sold them to a dealer. Fortunately, they came to the notice of Mr. Terrill, the well-known fancier who later developed the Opaline. He purchased as many as he could get from the dealer and firmly established them in this country.

The effect of the cinnamon is to suppress black melanin, allowing the brown to express itself and to alter the blue feather structure, while not affecting yellow pigment when present. This gives the body colour a somewhat paler appearance and brown wing markings instead of black.

### ***YELLOW FACED BLUE***

One of the most surprising and interesting of all mutations to evolve, appeared in England in 1936. Mrs. G. Lait of Grimsby bred the first Yellow Faced Blues and they were exhibited at the Yorkshire Observer show at Bradford in 1938.

Several different forms of Yellow Faced Blue have been identified. Prior to 1990 the most common form of Yellow Faced Blue in Australia was a mutation with a buttercup yellow face (perhaps the Goldenfaced Blue variation that was noted in England among the first examples of this variety), but in recent years these have been overshadowed by the English form which has a lighter shade of yellow (cream) and somewhat different pattern of reproduction.

## ***VIOLET***

To whom the credit must go for the first breeding of the Violet is somewhat doubtful, as they seem to have appeared in several places at the same time. They evolved in Australia during the early 1930's and took quite a time in becoming distributed among breeders, although today they have become quite well established and are a favourite among fanciers. As records are rather vague both in England and Australia as to when they first appeared, it could be supposed that they were not recognised for a time as a variant of the Cobalt. Mr Burton of Sydney, bred Violets prior to 1934, when they were exhibited by Harold Pier. They were being bred in Newcastle, New South Wales in 1936, and were also seen in Victorian aviaries about that time.

The Violet factor, like the Grey, is dominant and a colour intensity modifier. When it is added to the Greens and the Blues it produces birds that are somewhat different in colour to the original. Thus we can have Violet Light Green, Violet Dark Green, Violet Olive, Violet Skyblue, and so on.

## ***PIED***

When the first Pied budgerigar (a blue “splashed” with white) appeared in England in 1930, it was very aptly named “snowflake”, and its advent into the budgerigar world created something akin to sensation among the geneticists and aviculturists. The German scientists Consul-General Cremer and Dr. Duncker had a photograph taken and published on a full page in “Voegel Ferner Laender” (Birds of Far Away Countries). There were reports of others having been bred in France and Germany in 1932. However, although in this period they seem to have been established in Germany, efforts to increase their numbers failed and eventually they disappeared.

About 1933 the mutation was noticed in the aviaries of some prominent fanciers in both Sydney and Melbourne. In 1935 one was exhibited at the Royal Zoological Society show in Sydney. It was described as green, with half wings yellow and a bar of yellow across the body. This bird was purchased by Mr Keith Ings, together with the parents. These were normal in appearance, a Sky Blue cock and Olive hen. Birds produced from this trio are believed the ancestors of the Australian Dominant Pied (i.e. the banded morph of the Dominant Pied). The Dominant Pied can have a variable pattern of ground colour on their body including presence of a band, absence of any ground colour and the common variegated appearance.

Other Pies emerged in Holland, Belgium and Denmark over the years. These mutations are the basis for three distinct pied varieties: The Dominant Pied, the Clearflighted Dominant Pied and the Recessive Pied. Within the Clearflighted variety, the Dutch Dominant Pied and Continental Clearflighted Pied have been described but they appear to have arisen as mutations of the same gene since when either is combined with the Recessive Pied they produce offspring known as Dark Eyed Clears. The Dominant Pied does not produce Dark Eyed Clears, confirming that it is derived from mutation of a different gene. The Dominant Pied and the Clearflighted Dominant Pied can also be bred in double factor form which changes the extent of their markings.

The Recessive Pied was first bred in 1933-34 by Herr C. Enehjelm. They were not seen in Britain till 1948 when some of Herr Enehjelm's birds were imported. In Australia, Mr. Joe Wilmott of Merewether, New South Wales, was the first to recognise the Recessive Pied mutation. A green Recessive Pied cock was purchased from a pet shop in 1965. As the variety is recessive it was not until 1967 that Mr Wilmott bred Recessive Pies. From this beginning, he bred birds to a high standard in all colours and varieties and released the Recessive Pied to the Australian public in 1972.

### ***DARK EYED CLEAR***

Yellow or white Dark Eyed Clears are derived from Pieds however the history of this variety variation is unknown at this point and is being investigated by the ANBC. Once completed the historical record will be inserted in this section of *The Standard*.

### ***LACEWING***

It appears that these birds were being bred in various country areas of Queensland during the Second World War. Mr Tom Smith, one of the more knowledgeable Queensland fanciers, identified the variety, when, in 1959, he was asked to visit the aviaries of Mr Hector Hall of Kingaroy.

Mr Hall had been breeding these birds for the previous ten years and called on Mr. Smith to determine what they were. Mr Smith recognised them as Lacewings, which had already been reported as a mutation occurring in Britain about 1948. A study of Mr. Hall's breeding record for the previous five years confirmed they were a sex-linked variety.

### ***SPANGLE***

Birds of the variety now known as Spangle first appeared in the aviary of bird dealer Mr Sergio Casagrande of Reservoir, Victoria in 1971. These birds were observed by the Budgerigar Council of Australasia (B.C.A) Secretary Mr Harry Eady in 1972.

Establishment of the mutation is credited to Mr. Merv Jones, of Traralgon, Victoria, who first bred them in 1974 from a single bird described as a 'yellow face with funny wing marking' that he had purchased from his neighbour, Albert Richie. Within two years he had bred sixty similar birds and a number of clear yellow or white birds had appeared as well. Believing he had something different he sought the advice of the leading Victorian breeder, Mr Frank Gardner. Six of *the unusual looking* birds were taken to the Gardner Shield Show in 1976 for Mr Gardner to see. He confirmed that they were indeed a new mutation. The term 'spangley' had been used to describe the birds and Mr Gardner, seeing that they resembled the spangle markings in poultry, adopted the name Spangle for the new variety. Recognition that the clear yellow and white birds were the same mutation in double dose can be attributed to Mr Geoff Gardiner, a then young enthusiast who has gone on to become a leading fancier and Senior Judge in Victoria.

Spangle Double Factors have been bred in various forms, some almost pure self coloured, some with a collar of body colour and some like pale coloured Clearwings.

### ***CLEARBODY***

Among the birds imported into Australia in the early 1990's was examples of the Texas Clearbody. According to Ferdinand Wagner, in an article he wrote in 1988 for *Budgerigar World*, the Texas Clearbody first appeared in a colony breeding establishment in Texas (USA) in the early 1950s. He attributes their establishment to Iola Bays of California who obtained examples in the early 1960's and crossed them with imported English stock. The variety is sex linked in its mode of inheritance and is an allelomorph of the Ino mutation.

### ***DARKWING***

The Darkwing was described in *The Standard* of 1990 as Greywing Yellow and White and Cinnamonwing Yellow and White. For many years these birds were exhibited in the Greywing and Cinnamonwing Classes predominately in NSW. Standards for these birds are now included in the Any Other Variety Section contained in *The Standard*. The variety was developed by careful selection by Mr. Shaw, of Sydney, about 1934.

### ***CRESTED***

Mr Mathews of Sydney, New South Wales (N.S.W.), Australia bred the first recorded Crested mutation in the early 1920's. The European (Continental) Crested mutation occurred just prior to World War II and it is known that examples were imported into the United Kingdom in 1938. Mrs Brown of Moracambe, Lancashire, Great Britain had imported Crested birds from an Australian strain and was breeding them freely by 1938. A further Crested mutation was reported as having appeared in Canada around 1948. It would seem that British Crested have been developed by combining the Australian and European strains. The two strains differ only in the position of the centre of the crest (or Locus). The Continental strain has the centre of the crest just above the cere and the other (Australian) has the centre of the crest further back to the centre of the head. Over the years the two strains have intermingled such that either variant may be produced.

### ***AUSTRALIAN WHITE CAP***

This mutation was formally recognized by the ANBC in June 2013 as a new mutation and the name Australian White Cap was adopted. The mutation was first identified in the aviary of Graeme Kerle of Townsville (Qld) in 2003 by Kevin O'Callaghan who obtained birds and in turn gifted a pair to Nigel Tonkin and Jennie Liebich (SA) to ensure distance between stock in case of disaster and to better understand breeding habits and genetic data, which at this point is still a work in progress. This history will be updated when solid genetic facts are to hand and a presentation can be made to the ANBC to adopt the mutation and incorporate within *the Standard*.



## CONCLUSION

It should be noted that most of the mutations appeared within a relatively short time - 1915 to 1940. There was then a break of nearly 30 years to any outstanding new mutation being established. The advent of the Mottled in 1967, the Spangle in 1973, and the Saddleback in 1975 could have heralded the start of a new round of mutations, however, only the Texas Clearbody in 1991 (first bred in Australia from birds imported from the United Kingdom in 1990) has since come to notice.

The "Mottled" was bred in 1967 in the aviaries of A. & E. Dobie of Adelaide, South Australia. Similar in appearance to the Danish Recessive Pied, these birds leave the nest as a Normal and the Mottling gradually appears as they go through their first moult.

The first Saddleback was bred by L. & B. Ryan of Blacktown, New South Wales, from a pair of normal Skyblues. The mutation has Opaline characteristics in that the saddle or V area is clearly defined, not due to any absence of markings but because they are decidedly grey on an otherwise normal bird. Head markings are minimal but where they do appear they are also grey rather than black. Wing markings in the shoulder region are grey merging to black in the area of the secondary and primary flight feathers on a white or yellow ground. Although displaying Opaline characteristics the original mutant was a cock and could not be an Opaline. In 1976 the mutant mated back to his mother produced two more mutants, both cocks, in a nest of four. Hens were not produced until 1977. Further breeding has proved this variety to be recessive.

As far as possible, through interviews and the study of records, papers and books, this information is reasonably accurate, but it may well be that many mutants have appeared and disappeared over the years without any records being kept. At various times bi-colours and tri-colours have been reported, but they have been found not to reproduce the characteristic.

### PICTORIAL TREND OF STANDARDS

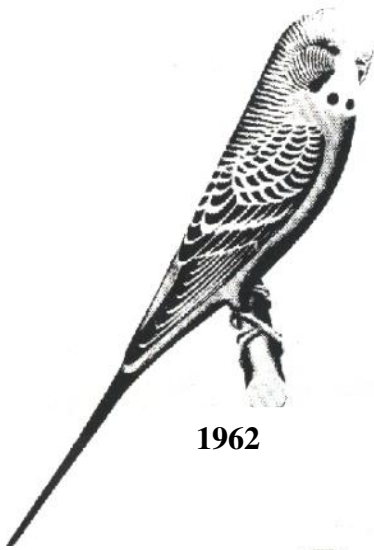

1962

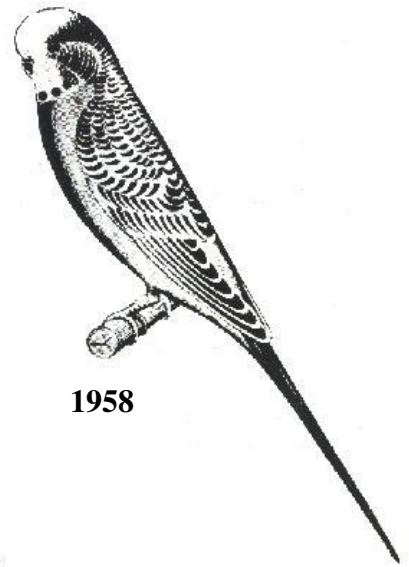

1958



2003



1935



1990



1949

## MAIN FEATURES OF A BUDGERIGAR

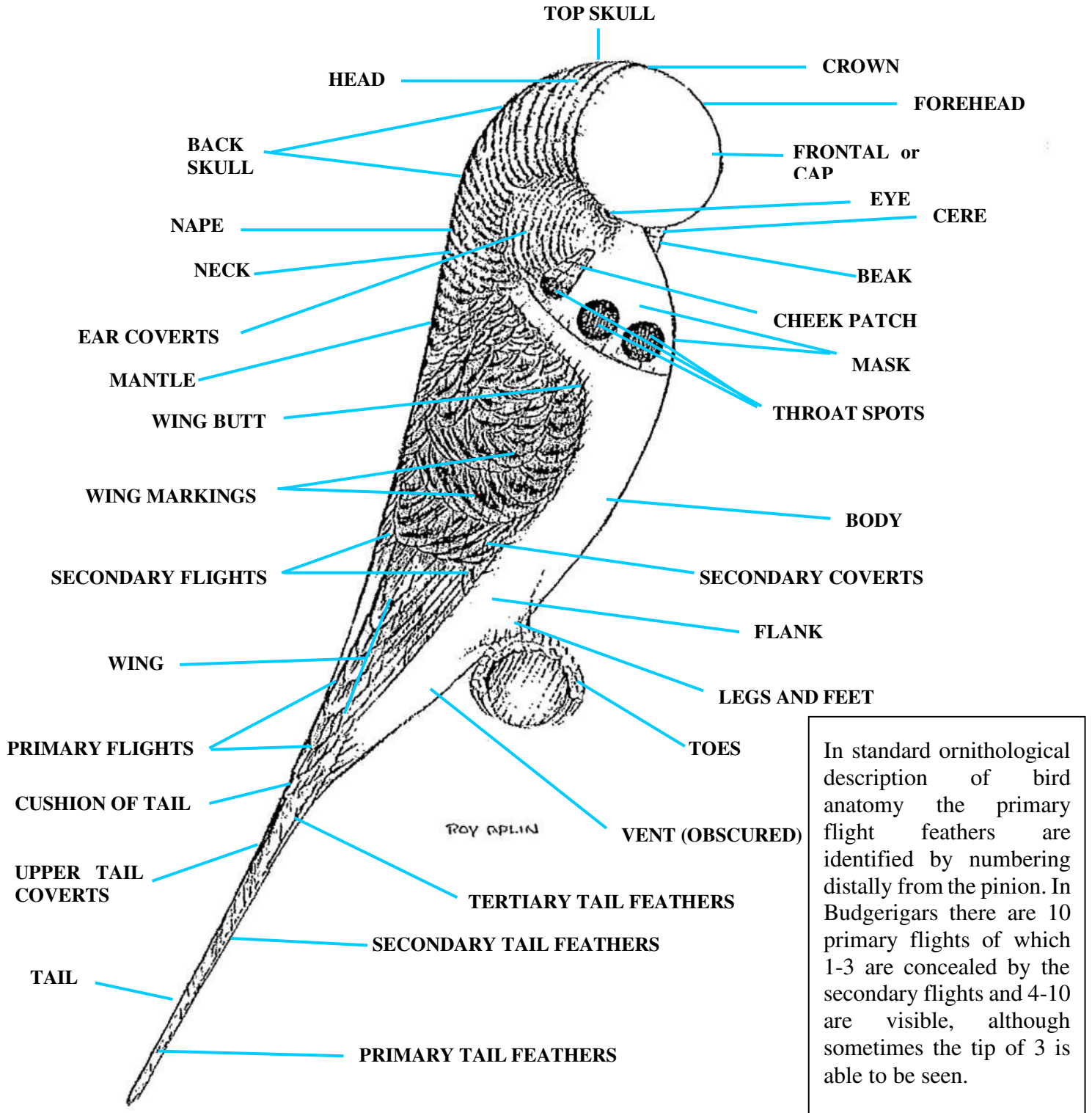

In standard ornithological description of bird anatomy the primary flight feathers are identified by numbering distally from the pinion. In Budgerigars there are 10 primary flights of which 1-3 are concealed by the secondary flights and 4-10 are visible, although sometimes the tip of 3 is able to be seen.

**The bird should be sleek and clean with no sign of injury or disease. It should be perfectly balanced and steady on the perch at an angle of 30 degrees from the vertical. Ideal length of the bird is 240 mm.**

Copyright: © Australian National Budgerigar Council Inc. (A.N.B.C. Inc.) 2003

## THE IDEAL



Copyright: © Australian National Budgerigar Council Inc. (ANBC Inc.) 2003

Updated February 2024



## IDEAL HEN AND COCK - BUST



ROY APPLIN

HEN



ROY APPLIN

COCK

**Sexual differences to be allowed for throughout *The Standard*. The Ideal Hen has slightly less frontal rise, less rounded top skull, a wider pelvis and a brown cere.**

Copyright: © Australian National Budgerigar Council Inc. (ANBC Inc.) 2003

## DESCRIPTION OF PERFECTION

### **Condition:**

The bird should be clean and sleek, complete in feather, showing vitality and good health with no sign of injury or disease.

### **Type:**

The bird is to taper gracefully and be well proportioned according to the pictorial of the time, standing well off the perch, at an angle of approximately 30 degrees from vertical, with beak tucked deep into mask, backline sweeping gently, in a slight concave from the back skull to the tip of the tail. Body line to curve out from the beak through the mask to the chest, and then taper back to the lower tail coverts of the tail.

### **Length:**

The ideal length is 240mm measured from the crown of the head to the tip of the tail.

### **Wings:**

Firmly braced close to the body, neat and not showing too much back. The tips of the primary flights to meet at or just above the cushion of tail. Seven or eight visual primary flights on each wing are acceptable.

### **Tail:**

Straight and tight with two primary feathers in proportion to the size of the bird. The ideal tail length is 35% of the length of the bird.

### **Head:**

The head feather is to give the appearance of the head being large, rounded and wide when viewed from any angle; curvature of the head feather is to commence at the cere in an outward, sideways and downward direction from the cere and then lift upward, continuing over the top of the head through a full backskull in one graceful sweep and merge into the backline & shoulders.

### **Eyes:**

Bright, set deep in the head, well down from the crown and slightly nearer to the beak than to the back of the head.

### **Cere:**

Neat and shapely, of a solid and even colour.

### **Beak:**

To be smooth and clean.

### **Mask and Spots:**

The mask is to be clear, wide and deep, (not cleft) extending beyond two large cheek patches. Where required by variety standards, the mask is to be ornamented by six evenly spaced, large, round throat spots, the outer two being partially covered by the base of the cheek patches.

### **Legs and Feet:**

To be clean, with two front and two rear toes and claws gripping the perch.

**Markings:**

Where required by the variety standards are to be well defined.

**Colour:**

Colour is in all cases to be pure and uniform in tone except where otherwise allowed in variety standards.

**SCALE OF POINTS****A GUIDE TO THE RELATIVE IMPORTANCE OF EXHIBITION FEATURES****TYPE****60 points (Refer Note 2 below for Crested)**

GENERAL CONFORMATION, INCLUDING SIZE, BALANCE, DEPARTMENT, CONDITION, HEAD SIZE AND SHAPE AND DEPTH AND WIDTH OF MASK.

(Refer to “Description of Perfection” and “Pictorials, including Crested Pictorials”).

**COLOUR AND MARKINGS****40 points (Refer Note 2 below for Crested)**

**COLOUR:** QUALITY OF COLOUR IN BODY, GROUND AREAS AND MARKINGS

**MARKINGS:** PATTERN AND CLEAR DEFINITION OR ABSENCE AS REQUIRED BY VARIETY STANDARDS

**ALLOCATION OF AVAILABLE POINTS FOR COLOUR AND MARKINGS TO BE DETERMINED BY THREE VARIETY GROUPINGS AS LISTED BELOW:**

<b>1. Colour and absence of body colour suffusion are of paramount importance</b>	<b>2. Emphasis on Markings and/or Varietal Features (Refer Note 2 Below)</b>	<b>3. Equal weight given to Colour &amp; Markings or absence of markings</b>
Red Eyed Self Spangle Double Factor Dark Eyed Clear Black Eyed Self	Opaline Greywing Cinnamonwing Clearbody Lacewing Fallow Spangle Recessive Pied Australian White Cap Saddleback Crested	Normal Green Series Normal Blue Series Normal Yellow Faced Blue Series Clearwing Dominant Pied Group Darkwing Dilute

NOTE 1: Combination varieties - allowance should be made accordingly.

NOTE 2: Given the Crested is the only Budgerigar with a distinct varietal feature affecting the outline the points for Type, Colour and Markings are to be allocated as follows –

- 30 Points – Prominence, neatness and central positioning of the Crest
- 50 Points – Type
- 20 Points - Colour and Markings

Refer to the written Standard for further expansion on the varieties of the Crest along with Penalty Clauses

## USE OF THIS STANDARD - MATRIX

1. For describing Standard Varieties.
2. As a guide and reference for Breeders and Judges.
3. As a guide and reference for exhibitors in ascertaining the classes in which to enter their exhibits.
4. As a guide for compiling show schedules.
5. Combinations of varieties accepted as standard are listed as groups under the primary variety in the combination. Such birds are described as:

Opaline (primary variety) Greywing (other variety) Sky Blue (colour).

For combinations of more than two varieties to be accepted as standard, every combination of the varieties involved must appear in the groups.

Standard Primary Colours & Varieties	Section Number	Recognized Combinations											
<b>Primary Colours</b>		As with any Green and Blue Series the Yellow Face Series Blue is recognized and accepted in sections 4-21											
Normal Green Series	1												
Normal Blue Series	2												
Yellow Faced Blue Series	3												
<b>Primary Varieties</b>													
Black Eyed Self	4												
Dilute	5												
Red Eyed Self	6												
Dark Eyed Clear	7												
Clearwing	8												
Greywing	9												
Cinnamonwing	10												
Spangle Double Factor	11												
Opaline	12												
Clearbody	13								12				
Lacewing	14								12				
Fallow	15					9			12				
Spangle	16					9	10		12			15	
Dominant Pied Group	17					9	10		12			15	16
Recessive Pied	18					9	10		12			15	16
Aust. White Cap Group	19	Recognised in 1 to 20 of the above groups/section											
AOSV	20												
Crested	21	Recognised in 1 to 20 of the above groups/sections											

Standard Primary Varieties 12-21 may combine with one or more than one of its group varieties, but will remain the primary variety for exhibition purposes. The largest number listed in the numerical list of sections and combinations is always the primary variety.

NOTE: The "Section Number" is the code number for *The Standard* Primary Variety it represents and includes any birds displaying the Violet Colour Intensity Modifier.



## VARIETY STANDARDS

GROUND COLOUR is the basic underlying colour upon which all other pigments and markings are superimposed.

This ground colour is Yellow in the Green Series (Light Green, Dark Green, Olive and Grey Green) and Yellows. The ground colour is White in the Blue Series (Sky Blue, Cobalt, Mauve, Violet and Grey) and Whites, noting that Yellow Faced varieties are an exception.

NOTE 1: On Grey Green and Grey the terms light, medium and dark describe the respective forms of Light Green, Dark Green and Olive (Green Series) or Sky Blue, Cobalt or Mauve (Blue Series). Density in body colour is to be even throughout.

NOTE 2: Ideal cere colour is blue on Cocks (unless otherwise stated), and brown on all Hens, regardless of variety.

NOTE 3: Pictorials are to be used as a reference as to any department or positioning of facets of the ideal budgerigar, i.e. eye position in head, spot placement in mask etc.

## DESCRIPTION OF COLOURS

### ***NORMAL SERIES: (GREEN, BLUE and YELLOW FACED BLUE)***

**MASK AND SPOTS:** The mask is to be clear, wide and deep, (not cleft) extending beyond two large cheek patches ornamented by six evenly spaced, large, round black throat spots, the outer two being partially covered by the base of the cheek patches.

**GENERAL BODY COLOUR:** Back, rump, breast, flanks and underparts to be a solid and even shade throughout.

**MARKINGS:** On cheeks, back of head, neck and wings - black, clearly defined and symmetrical on the appropriate ground colour and free from any intrusion of body colour or 'bloom'.

**EYES:** Black with a white iris ring.

**BODY COLOUR:** Full intensity.

**FEET & LEGS:** Blue/Grey.

Colour	Cheek Patch	Tail Quill	Tail Feather
LIGHT GREEN	Violet	Black	Mid Blue with Turquoise suffusion
DARK GREEN	Violet	Black	Dark Blue
OLIVE	Violet	Black	Dull Blue-Black
GREY GREEN	Grey	Black	Black
SKY BLUE	Violet	Black	Mid Blue with Turquoise suffusion
COBALT	Violet	Black	Dark Blue
MAUVE	Violet	Black	Very Dark Blue with Black Sheen
VIOLET	Violet	Black	Deep Royal Blue
GREY	Grey	Black	Black
YELLOW FACED	<i>Refer below for expanded commentary</i>		
AUSTRALIAN GOLDEN FACED	<i>Refer below for expanded commentary</i>		

## YELLOW FACED

### (Previously English Yellow Face)

The Standard will be as for all varieties in the blue series including grey and shall conform in every respect **except** in the following detail:

**GENERAL BODY COLOUR:** As for the corresponding non-yellow faced series colour with **minimal** intrusion of yellow affecting the purity of the Primary Colour

**MASK:** Cream/lemon colouration extending over the frontal and crown with minimal intrusion into the undulations at the back of the head.

**MARKINGS:** On cheeks, back of head, neck and wings a light flush of cream/lemon colour may be visible in the otherwise white areas at the edge of the markings

**TAIL FEATHERS;** Pale cream/lemon overlay on the white areas of the secondary tail feathers

**Note 1:** These birds can be bred in both Single factor and Double factor forms with the latter form being white faced and indistinguishable from the normal form of blue/grey

**Note 2:** Where Yellow Faced blue is combined with any variety which displays white ground colour **minimal** spillage of yellow from the mask is acceptable to the extent as described for normal Yellow Faced blue but varieties with reduced melanin are to be penalised for colour in proportion to departure from **minimal** (as described for the normal) to the extent where points for colour are **heavily penalised** in the self-coloured varieties.

## AUSTRALIAN GOLDEN FACED

(Previously Australian Yellow Faced Blue)

The Standard will be as for all varieties in the blue series including grey and shall conform in every respect except in the following detail:

GENERAL BODY COLOUR: As for the corresponding non-goldenfaced series colour with **minimal** intrusion of yellow affecting the purity of the Primary Colour

MASK: Deep buttercup yellow extending over the frontal and crown with minimal intrusion into the undulations at the back of the head.

MARKINGS: On cheeks, back of head, neck and wings a minimal flush of yellow visible in the otherwise white areas at the edge of the markings

TAIL FEATHERS: Buttercup yellow overlay on the otherwise white areas of the secondary tail feathers

**Note 1:** Australian Goldenfaced can be bred in single factor forms but only the double factor forms display the prescribed blue or grey colour. Dark factor combined with the single factor forms can proportionately mask the intrusion of yellow leading to shades of blue not penalised as heavily for colour as the sky blue form. Birds with no dark factor usually display yellow suffusion in the single factor form to the extent that a **sea green or grey green body colour results and thus this form attracts a disqualification as blue or grey is not evident visually.**

**Note 2:** Where Australian Goldenfaced is combined with any variety which displays white ground colour **minimal** spillage of yellow from the mask is acceptable to the extent as described for the normal goldenfaced blue but varieties with reduced melanin are to be penalised for colour in proportion to departure from **minimal** (as described for the normal) to the extent where points for colour are **heavily penalised** in the self-coloured varieties. Yellow intrusion is far stronger for the single factor forms and must be penalised accordingly.

### ***BLACK EYED SELF COLOUR:***

MASK: The mask is to be clear, wide and deep, (not cleft) extending beyond two large cheek patches.

GENERAL BODY COLOUR: Back, rump, breast flanks and under parts to be a solid and even shade throughout.

MARKINGS: Clear ground colour is the optimum. Faint markings are found on cheeks, back of head, neck and wings.

EYES: Dark with a white iris ring.

PRIMARY FLIGHTS: Approaching body colour.

FEET & LEGS: Pinkish, Blue/Grey, mottled.

NOTE: Visible Opaline characteristics are not permissible. The aim of this variety is to achieve an optimum of colour Yellow or White as the name ‘Self’ implies.

Colour	Cheek Patch	Tail Quill	Tail Feather
YELLOW (BUTTERCUP)	White suffused Pale Violet /Muted Grey	Neutral	Neutral with ground colour suffusion
WHITE	White suffused Pale Violet /Muted Grey	Neutral	Neutral with ground colour suffusion

**BLACK EYED SELF GROUP:** This includes Yellow Faced Blue Series. *The Standard* for these birds is as for Black Eyed White modified by the applicable Yellow Faced Blue colour with which it is combined.

NOTE: Visual Dilute Grey Greens (Grey Yellows in the old terminology, with mustard body colour) and heavily suffused Dilute Greys ( Grey Whites in the old terminology) are to be shown in the Dilute Class.

### ***DILUTE:***

**MASK AND SPOTS:** Mask to be clear, wide and deep, (not cleft) extending beyond large cheek patches ornamented by six evenly spaced, large, round faintly discernible throat spots, the outer two being partially covered by the base of the cheek patches.

**GENERAL BODY COLOUR:** To be an even shade throughout. Back, rump, breast, flanks and underparts are diluted by approximately 70% in the Light, Dark or Olive (Green Series) and in the Sky Blue, Cobalt, Mauve or Violet (Blue Series). Grey Green (previously known as Grey Yellow) is diluted to a mustard yellow and Grey (previously known as Grey White) is diluted to a pale grey.

**MARKINGS:** Pale Grey. Faint markings are found on cheeks, back of head, neck and wings.

**EYES:** Black with a white iris ring.

**PRIMARY FLIGHTS:** Yellow/White to very pale grey.

**FEET AND LEGS:** Pinkish, Blue/Grey mottled.

Colour	Cheek Patch	Tail Quill	Tail Feather
LIGHT GREEN	Pale blue to violet	Neutral	Yellowish white to pale blue
DARK GREEN	Pale blue to violet	Neutral	Yellowish white to pale blue but darker in proportion to Light Green
OLIVE GREEN	Pale blue to violet	Neutral	Yellowish white to pale blue but darker in proportion to Dark Green
GREY GREEN	Pale grey	Pale grey to black	Grey white to pale grey
SKY BLUE	Pale blue to violet	Neutral	Bluish white to pale blue
COBALT	Pale blue to violet	Neutral	Bluish white to pale blue but darker in proportion to Sky Blue

MAUVE	Pale blue to violet	Neutral	Bluish white to pale blue but darker in proportion to Cobalt
VIOLET	Pale violet	Neutral	Bluish white to pale blue but darker in proportion to Mauve
GREY	Pale grey	Pale grey to black	Grey white to pale grey

**DILUTE GROUP:** This includes Yellow Faced Blue Series. *The Standard* for these birds is as for the Dilute Blue series modified by the applicable Yellow Faced Blue colour with which it is combined.

**NOTE:** 1. Visible Opaline characteristics are not permissible.

***RED EYED SELF COLOUR:***

**MASK:** The mask is to be clear, wide and deep, (not cleft) extending beyond two large cheek patches.

**GENERAL BODY COLOUR:** Back, rump, breast, flanks and underparts to be a solid and even shade throughout.

**MARKINGS:** To be absent from all areas. Wings corresponding to body colour.

**EYES:** Red with a white iris ring.

**PRIMARY FLIGHTS:** Approaching body colour.

**FEET & LEGS:** Pink

**CERE:** Cocks Flesh Colour.

Colour	Cheek Patch	Tail Quill	Tail Feather
LUTINO (Buttercup Yellow)	White	White	Approaching body colour
ALBINO (White)	White	White	White

**RED EYED SELF GROUP:** This includes Yellow Faced Blue Series. *The Standard* for these birds is as for Albino modified by the applicable Yellow Faced Blue colour with which it is combined.

***DARK EYED CLEAR:***

**MASK AND SPOTS:** Mask to be clear, wide and deep, (not cleft) extending beyond two large cheek patches

**GENERAL BODY COLOUR:** Back, rump, breast, flanks and underparts to be a solid and even shade throughout.

**MARKINGS:** To be absent from all areas. Wings corresponding to body colour.

**EYES:** Dark with the absence of a white iris ring.

**PRIMARY FLIGHTS:** Approaching body colour.

**FEET & LEGS:** Pink.

**CERE:** Cocks flesh colour.

Colour	Cheek Patch	Tail Quill	Tail Feather
YELLOW (Buttercup)	White	White	Approaching body colour
WHITE	White	White	White

**DARK EYED CLEAR GROUP:** This includes Yellow Faced Blue Series combined with Dark Eyed Clear. *The Standard* for these birds is as for Dark Eyed Clear White modified by the applicable Yellow Faced Blue colour with which it is combined.

***CLEARWING:***

**MASK:** The mask is to be clear, wide and deep, (not cleft) extending beyond two large cheek patches.

**GENERAL BODY COLOUR:** Back, rump, breast, flanks and underparts to be a solid and even shade throughout. **MARKINGS:** Clear ground colour is the optimum. Faint markings are found on cheeks, back of head and neck. Wings are to be pure ground colour.

**EYES:** Black with a white iris ring.

**PRIMARY FLIGHTS:** Approaching ground colour.

**BODY COLOUR:** Approaching full intensity.

**FEET & LEGS:** Blue/Grey

Colour	Cheek Patch	Tail Quill	Tail Feather
LIGHT GREEN	Violet	Neutral	
DARK GREEN	Violet	Neutral	
OLIVE	Violet	Neutral	
GREY GREEN	Grey	Neutral	

SKY BLUE	Violet	Neutral	Neutral with ground or body colour suffusion for all
COBALT	Violet	Neutral	
MAUVE	Violet	Neutral	
VIOLET	Violet	Neutral	
GREY	Grey	Neutral	

**CLEARWING GROUP:** This includes Yellow Faced Blue Series. *The Standard* for these birds is as for the Clearwing Blue series modified by the applicable Yellow Faced Blue colour with which it is combined.

**GREYWING:**

**MASK AND SPOTS:** The mask is to be clear, wide and deep, (not cleft) extending beyond two large cheek patches ornamented by six evenly spaced, large, round grey throat spots, the outer two being partially covered by the base of the cheek patches.

**GENERAL BODY COLOUR:** Back, rump, breast, flanks and underparts to be a solid and even shade throughout.

**MARKINGS:** On cheeks, back of head, neck and wings, mid grey clearly defined and symmetrical on the appropriate ground colour.

**EYES:** Black with a white iris ring.

**BODY COLOUR:** Approaching full intensity.

**FEET & LEGS:** Blue/Grey mottled.

Colour	Cheek Patch	Tail Quill	Tail Feather
LIGHT GREEN	Violet	Grey	Smokey Grey with Blue Green suffusion
DARK GREEN	Violet	Grey	Dark Blue
OLIVE	Violet	Grey	Dull Blue Black
GREY GREEN	Grey	Grey	Grey
SKY BLUE	Violet	Grey	Greyish Blue
COBALT	Violet	Grey	Dark Blue
MAUVE	Violet	Grey	Dull Mauve
VIOLET	Violet	Grey	Royal Blue
GREY	Grey	Grey	Grey

**GREYWING GROUP:** This includes Yellow Faced Blue Series. *The Standard* for these birds is as for the Greywing Blue series modified by the applicable Yellow Faced Blue colour with which it is combined.

**CINNAMONWING:**

**MASK AND SPOTS:** The mask is to be clear, wide and deep, (not cleft) extending beyond two large cheek patches ornamented by six evenly spaced, large, round cinnamon throat spots, the outer two being partially covered by the base of the cheek patches.

**GENERAL BODY COLOUR:** Back, rump, breast, flanks and underparts to be a solid and even shade throughout.

**MARKINGS:** On cheeks, back of head, neck and wings, cinnamon clearly defined and symmetrical on the appropriate ground colour.

**EYES:** Dark with a white iris ring.

**BODY COLOUR:** Approaching full intensity.

**FEET & LEGS:** Pinkish Grey.

Colour	Cheek Patch	Tail Quill	Tail Feather
LIGHT GREEN	Violet	Brown	Cinnamon Light Blue Green
DARK GREEN	Violet	Brown	Cinnamon Mid Blue
OLIVE	Violet	Brown	Cinnamon Dark Blue
GREY GREEN	Grey	Brown	Cinnamon
SKY BLUE	Violet	Brown	Cinnamon Light Blue
COBALT	Violet	Brown	Cinnamon Mid Blue
MAUVE	Violet	Brown	Cinnamon Dark Blue
VIOLET	Violet	Brown	Cinnamon Violet
GREY	Grey	Brown	Cinnamon

**CINNAMONWING GROUP:** This includes Yellow Faced Blue Series. *The Standard* for these birds is as for the Cinnamonwing Blue series modified by the applicable Yellow Faced Blue colour with which it is combined.

**SPANGLE DOUBLE FACTOR:**

**MASK:** The mask is to be clear, wide and deep, (not cleft) extending beyond two large cheek patches.

**GENERAL BODY COLOUR:** Back, rump, breast, flanks and underparts to be a solid and even shade throughout.

**MARKINGS:** To be absent from all areas. Wings corresponding to body colour.

**EYES:** Black with a white iris ring.

**PRIMARY FLIGHTS:** Approaching full body colour.

**BODY COLOUR:** Full intensity.



FEET & LEGS: Blue/Grey, Pink or a mixture of both.

Colour	Cheek Patch	Tail Quill	Tail Feather
YELLOW (Buttercup)	Silvery White	Neutral	Approaching full body colour
WHITE	Silvery White	Neutral	Approaching full body colour

SPANGLE DOUBLE FACTOR GROUP: This includes Yellow Faced Blue Series. *The Standard* for these birds is as for Spangle Double Factor White modified by the applicable Yellow Faced Blue colour with which it is combined.

### **OPALINE:**

**MASK AND SPOTS:** The mask is to be clear, wide and deep, (not cleft) extending beyond two large cheek patches ornamented by six evenly spaced, large, round black throat spots, the outer two being partially covered by the base of the cheek patches.

**GROUND COLOUR:** Should extend over the back of the head and merge into the general body colour at a point level with the butt of the wings.

**GENERAL BODY COLOUR:** Back, rump, breast, flanks and underparts to be a solid and even shade throughout.

**MARKINGS:** On cheeks, back of head and neck – minimal grizzled. Wing markings black on the corresponding body colour. A clear "V" effect is desirable in the mantle area. Primary flight feathers should carry a muted colour flash and tail may be a muted colour.

**EYES:** Black with a white iris ring.

**BODY COLOUR:** Full intensity.

FEET & LEGS: Blue/Grey.

Colour	Cheek Patch	Tail Quill	Tail Feather
LIGHT GREEN	Violet	Black	Mid Blue with Turquoise suffusion
DARK GREEN	Violet	Black	Dark Blue
OLIVE	Violet	Black	Dull Blue Black
GREY GREEN	Grey	Black	Black
SKY BLUE	Violet	Black	Mid Blue with Turquoise suffusion
COBALT	Violet	Black	Dark Blue
MAUVE	Violet	Black	Very Dark Blue with Black sheen
VIOLET	Violet	Black	Deep Royal Blue
GREY	Grey	Black	Black

OPALINE GROUP: This includes Yellow Faced Blue Series, Black Eyed Self, Dilute, Clearwing, Greywing and Cinnamonwing combinations with Opaline. *The Standard* for each of these birds is as for Opaline modified by the requirements of the variety and colour with which it is combined.

**CLEARBODY:**

**MASK AND SPOTS:** The mask is to be clear, wide and deep, (not cleft) extending beyond two large cheek patches ornamented by six evenly spaced, large, round black throat spots, the outer two being partially covered by the base of the cheek patches.

**GENERAL BODY COLOUR:** Yellow (Buttercup) or White, masking a standard colour that may show as a faint minimal suffusion in the body and with more intensity over the rump and flank.

**MARKINGS:** On cheeks, back of head, neck and wings - black clearly defined and symmetrical on the appropriate ground colour.

**EYES:** Black with a white iris ring.

**PRIMARY FLIGHTS:** Neutral to Pale Grey (Grizzling is acceptable).

**FEET & LEGS:** Blue/Grey mottled or Pink.

Colour	Cheek Patch	Tail Quill	Tail Feather
YELLOW (Buttercup)	Violet/Grey	Black	Dark Blue - Black
WHITE	Violet/Grey	Black	Dark Blue - Black

**CLEARBODY GROUP:** This includes Yellow Faced Blue Series and Opaline (without any combinations) combined with Clearbody. *The Standard* for each of these birds is as for Clearbody modified by the requirements of the variety and colour with which it is combined.

**NOTE 1:** Body Colour suffusion (minimal) should increase in depth of shade progressively from the upper breast to the rump area.

**NOTE 2:** The Clearbody Opaline (without any combinations) may be more likely to be Buttercup Yellow (green series) or White (blue series) but they should not be given preference over other standard Clearbodies (non Opaline) because of this. Grey factor birds will further modify the body colour. In the combination of these two varieties, suffusion on the back and rump is as per the General Body Colour description of the Clearbody.

**LACEWING:**

**MASK AND SPOTS:** The mask is to be clear, wide and deep, (not cleft) extending beyond two large cheek patches ornamented by six evenly spaced, large, round cinnamon throat spots, the outer two being partially covered by the base of the cheek patches.

**GENERAL BODY COLOUR:** Back, rump, breast, flanks and underparts to be a solid and even shade throughout.

**MARKINGS:** On cheeks, back of head, neck and wings, cinnamon clearly defined and symmetrical on the appropriate ground colour.

**EYES:** Red with a white iris ring.

**FEET & LEGS:** Pink.

**CERE:** Cocks flesh colour.

Colour	Cheek Patch	Tail Quill	Tail Feather
YELLOW	Pale Violet	Neutral	Pale Cinnamon
WHITE	Pale Violet	Neutral	Pale Cinnamon

LACEWING GROUP: This includes Yellow Faced Blue Series and Opaline combined with Lacewing. *The Standard* for each of these birds is as for Lacewing modified by the requirements of the variety and colour with which it is combined.

**FALLOW:**

MASK AND SPOTS: The mask is to be clear, wide and deep, (not cleft) extending beyond two large cheek patches ornamented by six evenly spaced, large, round dark brown throat spots, the outer two being partially covered by the base of the cheek patches.

GENERAL BODY COLOUR: Approaching half intensity may carry intensified colour over rump and back.

MARKINGS: On cheeks, back of head, neck and wings, dark brown clearly defined and symmetrical on the appropriate ground colour.

EYES: Red with a white iris ring and Red with no iris ring shall be accepted, the former being the German form of Fallow, the latter being the English form.

FEET & LEGS: Pink.

CERE: Cocks Flesh colour.

Colour	Cheek Patch	Tail Quill	Tail Feather
LIGHT GREEN	Violet	Dark Brown	Bluish Brown
DARK GREEN	Violet	Dark Brown	Bluish Brown
OLIVE	Violet	Dark Brown	Bluish Brown
GREY GREEN	Grey	Dark Brown	Brown
SKY BLUE	Violet	Dark Brown	Bluish Brown
COBALT	Violet	Dark Brown	Bluish Brown
MAUVE	Violet	Dark Brown	Bluish Brown
VIOLET	Violet	Dark Brown	Violet Brown
GREY	Grey	Dark Brown	Brown

FALLOW GROUP: This includes Yellow Faced Blue Series, Greywing and Opaline combinations with Fallow. *The Standard* for these birds is as for Fallow modified by the requirements of the variety and colour with which it is combined.

NOTE: The Fallow Opaline body colour is generally noticeably paler than that described under General Body Colour for this variety. Grey factor birds may further modify the intensity of the body colour.

**SPANGLE:**

**MASK AND SPOTS:** The mask is to be clear, wide and deep, (not cleft) extending beyond two large cheek patches ornamented by six evenly spaced, large, round black marked throat spots with ground colour centres, the outer two being partially covered by the base of the cheek patches.

**GENERAL BODY COLOUR:** Back, rump, breast, flanks and under parts to be a solid and even shade throughout.

**MARKINGS:** On cheeks, back of head and neck - black, clearly defined and symmetrical on the appropriate ground colour.

**WING MARKINGS:** Each covert and flight feather of appropriate ground colour with a fine black marking near the edge.

**EYES:** Black with a white iris ring.

**BODY COLOUR:** Full intensity.

**FEET & LEGS:** Blue/Grey, Pink or a mixture of both.

Colour	Cheek Patch	Tail Quill	Tail Feather
LIGHT GREEN	Violet and/or Silvery White	Neutral	Yellow or Yellow Edged with Black
DARK GREEN	Violet and/or Silvery White	Neutral	“
OLIVE	Violet and/or Silvery White	Neutral	“
GREY GREEN	Grey and/or Silvery White	Neutral	“
SKYBLUE	Violet and/or Silvery White	Neutral	White or White Edged with Black
COBALT	Violet and/or Silvery White	Neutral	“
MAUVE	Violet and/or Silvery White	Neutral	“
VIOLET	Violet and/or Silvery White	Neutral	“
GREY	Grey and/or Silvery White	Neutral	“

NOTE 1: Tail feathers edged with black may carry a darker quill.

NOTE 2: Ground colour, body colour and light clearly defined black markings near the edge of each covert is acceptable for wing markings on Spangle Opaline.

**SPANGLE GROUP:** This includes Yellow Faced Blue Series, Greywing, Cinnamonwing, Opaline and Fallow combinations with Spangle. *The Standard* for each of these birds is as for Spangle modified by the requirements of the variety and colour with which it is combined.

## ***PIED GROUPS***

A Pied Budgerigar displays areas of ground colour in place of body colour and/or markings. There are three genetically distinct Pied varieties: Dominant Pied, Clearflighted Dominant Pied and Recessive Pied, each with variable expression of their Pied gene. Dark Eyed Clear is a composite variety with at least one dominant gene from the Clearflighted Dominant Pied and two recessive genes from the Recessive Pied.

NOTE 1: Any Normal bird showing an area of Yellow (green series) or White (blue series) foreign to the variety it represents is pied marked.

NOTE 2: A ground colour spot on the back of the head or odd ground colour feathers on other parts of the body do not satisfy the requirements for any of *The Standard* pied varieties.

NOTE 3: Pied cheek patches when present are visually white.

NOTE 4: The Clearflighted Dominant Pied group consists of the Dutch Dominant Pied and the Clearflighted Dominant Pied. The Dutch Dominant Pied is more commonly found in Australia and has been included in this section and the Clearflighted Dominant Pied has been included under Phenotype Variants.

### ***DOMINANT PIED:***

**MASK AND SPOTS:** The mask is to be clear, wide and deep, (not cleft) extending beyond two large cheek patches ornamented by six evenly spaced, large, round black throat spots, the outer two being partially covered by the base of the cheek patches.

NOTE: Six spots are optimal but any number may be absent.

**GENERAL BODY COLOR:** Back, rump, breast, flanks and under parts to be a solid and even shade throughout except that ground colour may appear on the chest as a band or as patches on any part(s) of the body. Symmetry in distribution of these patches is desirable.

A complete band of ground colour, approximately 20mm wide and extending across the body approximately midway between the lower edge of the mask and the legs is optimal.

**MARKINGS:** Black and clearly defined on cheeks, back of head, neck and wings – but may be replaced by patches of ground colour in any area. Markings should be symmetrical.

**EYES:** Black with a white iris ring.

**BODY COLOUR:** Full intensity.

**FEET & LEGS:** Blue/Grey mottled although pink areas clear of skin pigment may appear on one foot/leg or both.

**PRIMARY FLIGHTS:** Yellow (buttercup) or White are optimal but normal coloured feathers may be present. Symmetry in the distribution of normal coloured feathers is desirable.

**PRIMARY TAIL FEATHERS:** Yellow (buttercup) or White are optimal but normal coloured feathers may be present.

NOTE 1: Colours for body, cheek patches, tail quill and tail feather are as for Normal with the exceptions noted above.

NOTE 2: Some clubs may provide additional classes which distinguish between the Banded Dominant Pied morph of the Dominant Pied genotype. These are benched and judged under arrangements determined by those clubs.

DOMINANT PIED GROUP: This includes Yellow Faced Blue Series, Greywing, Cinnamonwing, Opaline, Fallow and Spangle combinations with Dominant Pied. *The Standard* for each of these birds is as for Dominant Pied modified by the requirements of the variety and colour with which it is combined.

***DUTCH DOMINANT PIED:***

MASK AND SPOTS: The mask is to be clear, wide and deep, (not cleft) extending beyond two large cheek patches ornamented by six evenly spaced, large, round black throat spots, the outer two being partially covered by the base of the cheek patches.

GENERAL BODY COLOUR: Back, rump, breast, flanks and under parts to be a solid and even shade throughout but broken with no more than 50% of total body colour area by patches of ground colour restricted, in the main, to the top part of the body. A spot of ground colour should be present on the back of the head.

MARKINGS: On cheeks, back of head, neck and wings - black, clearly defined and symmetrical on the appropriate ground colour and free from any intrusion of body colour or 'bloom'. Wing markings may be grizzled in appearance.

EYES: Black with a white iris ring.

BODY COLOUR: Full intensity.

FEET & LEGS: Blue/Grey mottled although pink areas clear of skin pigment may appear on one foot/leg or both.

PRIMARY FLIGHTS: Yellow (buttercup) or White are optimal but normal coloured feathers may be present. Symmetry in the distribution of normal coloured feathers is desirable.

PRIMARY TAIL FEATHERS: Yellow (buttercup) or White are optimal but normal coloured feathers may be present.

NOTE 1: Colours for body and cheek patches are as for Normal with the exceptions noted above.

NOTE 2: Each individual feather may contain both ground colour and body colour (frosted).

DUTCH DOMINANT PIED GROUP: This includes Yellow Faced Blue Series, Greywing, Cinnamonwing, Opaline, Fallow and Spangle combinations with Dutch Dominant Pied. *The Standard* for each of these birds is as for Dutch Dominant Pied modified by the requirements of the variety and colour with which it is combined."

***RECESSIVE PIED***

**MASK AND SPOTS:** The mask is to be clear, wide and deep, (not cleft) extending beyond two large cheek patches ornamented by six evenly spaced, large, round black throat spots, the outer two being partially covered by the base of the cheek patches.

**NOTE:** Six spots are optimal.

**GENERAL BODY COLOUR:** Irregular patches of ground colour and body colour with the latter mainly on the lower chest, rump and under parts. Where present, body colour should be a solid and even shade.

**MARKINGS:** On cheeks, back of head, neck - black with a well-defined buttercup yellow or white ground. Wing markings should be black undulations/and or black dots on a buttercup yellow or white ground, random in pattern and distribution and covering 10% to 20% of the total wing area.

The frontal and crown of the head should be clear and free from all markings.

**CHEEK PATCHES:** Violet/Silvery White or Grey/Silvery White.

**EYES:** Dark with the absence of a white iris ring.

**FEET & LEGS:** Pink

**CERE:** Cocks flesh colour.

Non-pied areas must conform in colour and markings to the corresponding variety the bird represents.

**RECESSIVE PIED GROUP:** This includes Yellow Faced Blue Series, Greywing, Cinnamonwing, Opaline, Fallow and Spangle combinations of Recessive Pied. *The Standard* for each of these birds is as for Recessive Pied modified by the requirements of the variety and colour with which it is combined.

***AUSTRALIAN WHITE CAP GROUP******AUSTRALIAN WHITE CAP SINGLE FACTOR***

**MASK AND SPOTS:** The mask is to be clear, wide and deep, (not cleft) light yellow in colour and extending beyond two large cheek patches ornamented by six evenly spaced, large, round black throat spots, the outer two being partially covered by the base of the cheek patches. Adjacent to the

cheek patches are several white tipped mask feathers. Spots can also usually carry a white tip in the barbs that emanate from the base of the spot feather.

**GENERAL BODY COLOUR:** As for the underlying variety or colour with an even infused wash of yellow over the entire area of body colour including the rump area.

Back, rump, breast, flanks and under parts to be a solid and even shade throughout. Colour will vary for each shade of blue and grey, but evenness of body colour is paramount. On cheeks and ear coverts, a slight tinge of yellow is visible in place of the white areas of the Normal.

**CAP:** White feathers over a pale underlying cream base extending over the frontal and crown.

**MARKINGS:** Back of head, nape of neck and wings – black, clearly defined and symmetrical on white ground colour and free of any intrusion of body colour or ‘bloom’.

**EYES:** Black with a white iris ring.

**TAIL:** Secondary and Tertiary tail feathers carry light yellow pigmentation.

**FEET & LEGS:** Blue / Grey

### ***AUSTRALIAN WHITE CAP DOUBLE FACTOR***

**MASK AND SPOTS:** The mask is to be clear, wide and deep, (not cleft) yellow in colour and extending beyond two large cheek patches ornamented by six evenly spaced, large, round black throat spots, the outer two being partially covered by the base of the cheek patches. Adjacent to the cheek patches are several white tipped mask feathers. Spots can also usually carry a white tip in the barbs that emanate from the base of the spot feather.

**GENERAL BODY COLOUR:** Green as for the normal series. Back, rump, breast, flanks and underparts to be a solid and even shade throughout.

**MARKINGS:** On cheeks, back of head, neck and wings - black, clearly defined and symmetrical on the appropriate ground colour and free from any intrusion of body colour or ‘bloom’.

**CAP:** White feathers over an underlying yellow base extending over the frontal and crown however as the bird matures the cap may turn pale yellow. A small half circle of yellow feathers will be evident at the front of the cap adjacent to top of the cere.

**BODY COLOUR:** Full intensity and identical to the normal Green Series

**EYES:** Black with a white iris ring.

**TAIL:** Secondary and Tertiary tail feathers carry light yellow pigmentation.

**FEET & LEGS:** Blue / Grey

**NOTE** – Australian White Cap group includes all varieties. The Standard for each is as for the Australian White Cap modified by the requirements of the variety and colour with which they are combined.



**CRESTED:**

Three forms are recognised - FULL CIRCULAR, HALF CIRCULAR and TUFTED and their ideal forms are as illustrated in *the Standard*.

In every case, the crest should be large in size and complete in feathering so that it is the prominent feature. The 'ideal' crest is to be allocated a maximum of **30 points**, refer Scale of Points. Except for this additional feature affecting the outline, *the Standard* for Crested is as for the Colour and Variety involved and the remaining **70 points** are allocated for Type, Colour and Markings.

**FULL CIRCULAR:** Should be a full flat round crest with feathers radiating from the centre of the head. The Crest should fall in a neat circle around the head and be complete in feather.

**HALF CIRCULAR:** Should be a forward facing half circle of feathers radiating from the centre of the head, falling or raised ideally 8mm in a fringe above the cere.

**TUFTED:** Should be an upright crest of feathers ideally 8mm high rising from just above the centre of the cere.

**NOTE:** While only these three forms of Crest are recognised the FULL CIRCULAR is seen as the ideal expression of the variety and preferred over the HALF CIRCULAR which in turn is preferred over TUFTED. Size, symmetry and central placement of the crest is seen as a paramount feature.

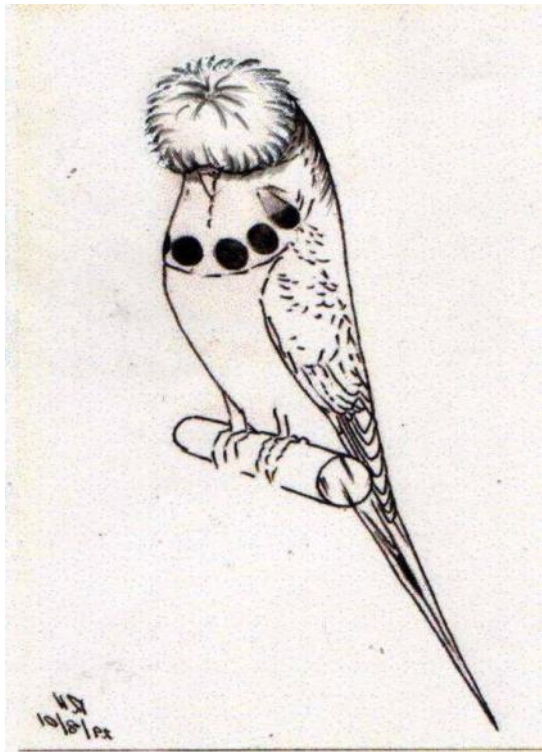

Full Circular  
Tufted

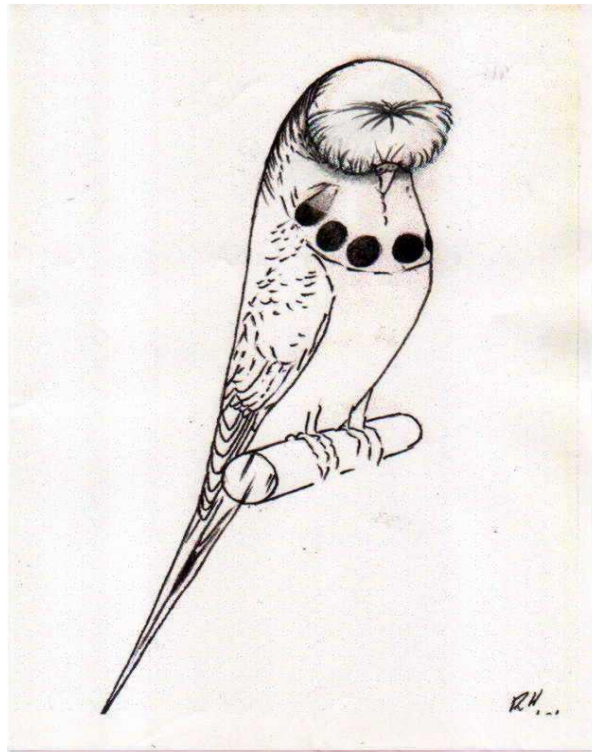

Half Circular  
Tufted

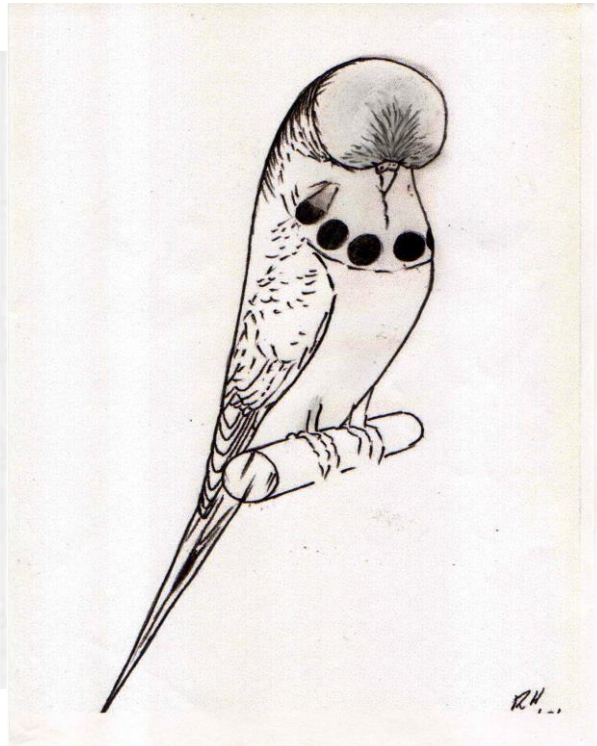
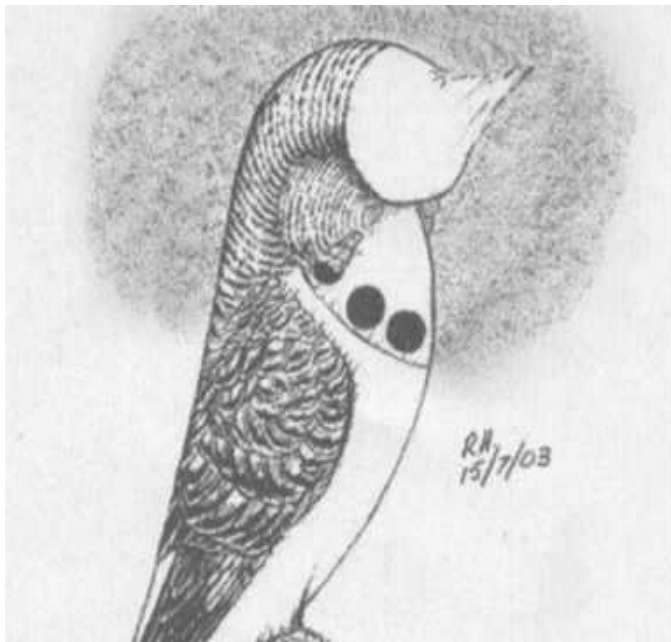

Copyright: © Australian National Budgerigar Council Inc. (ANBC Inc.) 2003

Updated February 2024

## OTHER VARIETIES, PHENOTYPE VARIANTS and COMBINATIONS

### OTHER VARIETIES

The following varieties are included in the section headed Any Other Standard Varieties in the Matrix page of *The Standard*. They are recognized and recommended for inclusion by member bodies/clubs in Any Other Standard Variety Classes (should such classes be provided).”

#### **SADDLEBACK:**

**MASK AND SPOTS:** Mask to be clear, wide and deep, (not cleft) extending beyond large cheek patches containing six large, round evenly spaced black spots. Each outer spot is partially covered by the base of the cheek patches.

**GROUND COLOUR:** Must extend over the back of the head into the mantle. Dark grey grizzled suffusion must appear in the ground colour on back of head and mantle.

**GENERAL BODY COLOUR:** Back, rump, breast, flanks and underparts to be a solid and even shade throughout.

**MARKINGS:** On cheeks, back of head, neck and mantle -- minimal. Wing markings, grey in the wing coverts, heavily grizzled with ground colour, merging to a definite black in the secondary and primary flights.

**EYES:** Black with a white iris ring.

**BODY COLOUR:** Full intensity.

Colour	Cheek Patch	Tail Quill	Tail Feather
LIGHT GREEN	Violet	Black	Mid Blue with Turquoise suffusion
DARK GREEN	Violet	Black	Dark Blue
OLIVE	Violet	Black	Dull Blue Black
GREYGREEN	Grey	Black	Black
SKYBLUE	Violet	Black	Mid Blue with Turquoise suffusion
COBALT	Violet	Black	Dark Blue
MAUVE	Violet	Black	Very Dark Blue with Black sheen
VIOLET	Violet	Black	Deep Royal Blue
GREY	Grey	Black	Black

**SADDLEBACK GROUP:** This includes Yellow Faced Blue Series combined with Saddleback. *The Standard* for these birds is as for the Saddleback Blue series modified by the applicable Yellow Faced Blue colour with which it is combined.

***DARKWING: (previously Cinnamonwing Yellow/White and Greywing Yellow/White).***

The Darkwing gene is a markings variety only and has little or no effect on body colour. There can be a Darkwing form of all other varieties of budgerigars however, its effect is not visible on all varieties. The Darkwing variety effects can be seen on Clearwing, Greywing and Black Eyed Self varieties only.

**MASK AND SPOTS:** Mask to be clear, wide and deep, (not cleft) extending beyond large cheek patches containing six large, round evenly spaced dark grey or black spots. Each outer spot is partially covered by the base of the cheek patches.

**GENERAL BODY COLOUR:** Back, rump, breast, flanks and underparts to be a solid and even shade throughout.

**MARKINGS:** On cheeks, back of head, neck and wings, approaching black, clearly defined and symmetrical on appropriate ground colour.

**EYES:** Black with a white iris ring.

**BODY COLOUR:** Yellow or White, showing a standard colour as a suffusion.

Colour	Cheek Patch	Tail Quill	Tail Feather
YELLOW - LIGHT	Pale violet to pale grey	Smokey black	Blue
YELLOW - DARK	Pale violet to pale grey	Smokey black	Blue
YELLOW - OLIVE	Pale violet to pale grey	Smokey black	Blue
YELLOW - GREY	Pale grey	Smokey black	Black
WHITE - SKY	Pale violet to pale grey	Smokey black	Blue
WHITE - COBALT	Pale violet to pale grey	Smokey black	Blue
WHITE - MAUVE	Pale violet to pale grey	Smokey black	Blue
WHITE - VIOLET	Pale violet to pale grey	Smokey black	Blue
WHITE - GREY	Pale grey	Smokey black	Black

**DARKWING GROUP:** This includes Yellow Faced Blue Series, Opaline and Cinnamonwing combinations with Darkwing. *The Standard* for each of these birds is as for Darkwing modified by the requirements of each of the varieties with which it is combined.

Note 1: Colour of markings on double factor birds are darker than markings on single factor birds.

Note 2: The cheek patch for the Cinnamon form may be paler than the Non Cinnamon form

Note 3: The Darkwing combined with Opaline and/or Cinnamonwing may be more likely to be Yellow (or White) (i.e. less suffused with a standard colour on body) but they should not be given preference over the other standard Darkwings (i.e. non Opaline and non Cinnamonwing).

## PHENOTYPE VARIANTS

The following variants of the PIED GROUP are included in this Standard as a guide only and as a reference for Breeders and Judges for use by member bodies/clubs who may wish to separate further the Dominant Pied and Clearflighted Dominant Pied groups in *The Standard*. Should these additional classes not be provided in showing schedules all Dominant PIEDs will be included in the Matrix page of *The Standard*.

### **BANDED DOMINANT PIED: (Previously known as the Australian Dominant Pied).**

**MASK AND SPOTS:** The mask is to be clear, wide and deep, (not cleft) extending beyond two large cheek patches ornamented by six evenly spaced, large, round black throat spots, the outer two being partially covered by the base of the cheek patches.

**GENERAL BODY COLOUR:** Back, rump, breast, flanks and under parts to be a solid, even shade throughout except that a complete band of ground colour, approximately 20mm wide, should extend across the body approximately midway between the lower edge of the mask and the legs.

Body colour should be complete between the upper edge of the band and the lower edge of the mask and between the lower edge of the band and the rest of the body and the band should be clearly defined between the pied and non-pied colours.

**MARKINGS:** On cheeks, back of head, neck and wings - black, clearly defined and symmetrical. The body should be of a solid ground colour except for the band that should be clearly defined.

Flight feathers and tail feathers should be clear, however dark feathers in the primary flights or primary tail, whilst undesirable, are not considered a serious fault. Dark feathers, if present, should not be variegated or grizzled.

A head spot may be present without penalty

**EYES:** Black with a white iris ring.

**BODY COLOUR:** Full intensity.

**FEET & LEGS:** Blue/Grey mottled although pink areas clear of skin pigment may appear on one foot/leg or both.

Colours for body, cheek patches, tail quill and tail feather are as for Normal with the exceptions noted above.

**BANDED DOMINANT PIED GROUP:** This includes Yellow Faced Blue Series, Greywing, Cinnamonwing, Opaline, and Spangle combinations with the Banded Pied. *The Standard* for each of these birds is as for the Banded Pied modified by the requirements of the variety and colour with which it is combined.

***CLEARFLIGHTED DOMINANT PIED:***

**MASK AND SPOTS:** The mask is to be clear, wide and deep, (not cleft) extending beyond two large cheek patches ornamented by six evenly spaced, large, round black throat spots, the outer two being partially covered by the base of the cheek patches.

**GENERAL BODY COLOUR:** Back, rump, breast, flanks and under parts to be a solid and even shade throughout. Uniform body colour not broken by patches of ground colour is optimal. A spot of ground colour is present on the back of the head.

**MARKINGS:** On cheeks, back of head, neck and wings - black, clearly defined and symmetrical on the appropriate ground colour and free from any intrusion of body colour or 'bloom'. Wing markings may be grizzled in appearance.

**EYES:** Black with a white iris ring.

**BODY COLOUR:** Full intensity.

**FEET & LEGS:** Blue/Grey mottled although pink areas clear of skin pigment may appear on one foot/leg or both.

**PRIMARY FLIGHTS:** Yellow (buttercup) or White

**PRIMARY TAIL FEATHERS AND QUILL:** Yellow (buttercup) or White

**NOTE 1:** Colours for body and cheek patches are as for Normal.

**CLEARFLIGHTED DOMINANT PIED GROUP:** This includes Yellow Faced Blue Series, Greywing, Cinnamonwing, Opaline, Fallow, and Spangle combinations with Clearflighted Dominant Pied. *The Standard* for each of these birds is as for Clearflighted Dominant Pied modified by the requirements of the variety and colour with which it is combined.

## COMBINATIONS

The following combination of colours and varieties is included in this Standard as a guide only and as a reference for Breeders and Judges and for use by member bodies/clubs who may wish to separate further the Opaline Any Other Standard Variety section in *The Standard*.

Should that additional class not be provided in showing schedules all Rainbows will be included in the Opaline Any Other Standard Variety section of the Matrix in this *Standard*.

### **RAINBOW:**

The Standard for this varietal combination will be that of the Opaline Clearwing Blue Series / Violet / Grey which also includes the addition of Yellowfaced or Australian Golden Faced.

The Rainbow is not considered a proper example unless the variety is clearly and visibly a Opaline Clearwing Yellowfaced or Opaline Clearwing Australian Golden Faced Blue / Grey.

**MASK AND SPOTS:** Mask to be clear, wide and deep, (not cleft) extending beyond large cheek patches containing six large round evenly spaced barely visible ghosted grey spots. Each outer spot is partially covered by the base of the violet / grey cheek patch.

**GROUND COLOUR:** Should extend over the back of the head and merge into the general body colour at a point level with the butt of the wings.

**GENERAL BODY COLOUR:** Rump, breast, flanks and underparts to be a solid and even shade throughout and approaching full intensity however a spillage of yellow will be evident and that level of spillage will depend on the Yellowfaced variety with which the bird is linked (refer Note 1 Below)

**MARKINGS:** On cheeks, back of head and neck – minimal grizzled. Wing markings are ghosted grey on the corresponding white ground colour. A clear "V" effect is desirable in the mantle area. Primary flight feathers will carry a muted yellow coloured flash and tail may be a muted colour and that yellow hue is again also acceptable.

**EYES:** Black with a white iris ring.

**FEET & LEGS:** Blue/Grey

**PRIMARY TAIL FEATHERS:** Quill neutral with feathers mainly neutral with minor ground or body colour suffusion.

**NOTE 1 –** The level and intensity of yellow body and ground colouration will vary and be dependent upon which of the Yellowfaced mutations is present. Yellowfaced will appear as lemon yellow while the double factor Australian Goldenfaced will be a much deeper and more vibrant yellow. As the name suggests a diverse and bright appearance in colour is the desired exhibition combination."

**PAIRS, TEAMS AND COLLECTIONS:**

Although not included in the National Competition, the following Standards are provided for guidance to member bodies.

**Pairs:** A pair shall consist of a cock and hen, each of the same standard colour and variety.

**Teams:** A team shall consist of three (3) birds of the same standard colour, variety and sex or a tri-coloured team of one standard variety, three different standard colours of one sex.



**Collections:** A collection shall consist of three (3) birds of one sex, but of different standard varieties, (not colour variations of the one variety) and any standard colour OR three (3) birds of one sex, but of different standard varieties (not colour variations of the one variety) and the one standard colour.





## BUDGERIGAR PENALTY AND DISQUALIFICATION CLAUSES FOR GUIDANCE OF ANBC JUDGES AND EXHIBITORS

(THESE GUIDELINES ARE SET AND MAINTAINED BY THE ANBC  
JUDGES PANEL WHO RETAIN SOLE OWNERSHIP OF THE CONTENT)

<p><b>Symptoms of Illness</b></p>	<p><b><u>Disqualification</u></b> Ruffled, huddled in appearance, sometimes with vomiting and/or diarrhoea (often described as ‘dirty’ vent but not to be confused with nervous wet vent) <b>Remove from the bench</b></p>
<p><b>Presence of Mites</b></p> 	<p><b><u>Disqualification</u></b> Scaly face - Encrustations visible on one or more of the cere, beak, legs, eyes and vent. Feather mite - Ragged black or brown markings on feathers, particularly on the side toward the vent area <b>Remove from the bench</b></p>
<p><b>Presence of Lice</b></p>  	<p><b><u>Disqualification</u></b> Visible usually on face, mask or neck as black ‘dots’ or fly shaped - flat &amp; fast moving. Each disappear into the feather when disturbed <b>Remove from the bench</b></p>
<p><b>Deformity or Injury</b></p>	<p><b><u>Disqualification</u></b> <i>Feathering</i> – evidence of feather plucking, obvious French Moults, more than two primary tail feathers. <i>Deformity of Foot/Feet</i> – three or more toes permanently facing forward, inability to grip the perch, missing toe/s or part thereof – not toe nails, callusing on the sole of the foot. <i>Other major problems</i> – undershot beak, dislocated joints, substantial bleeding. <b><u>Penalty</u></b></p> <ul style="list-style-type: none"> <li>• Twisted primary tail feather/s – the greater the degree of twisting, the greater the penalty.</li> <li>• Broken or missing or twisted toe nails [not toes]</li> </ul>
<p><b>Condition</b></p>	<p><b><u>Disqualification</u></b></p> <ul style="list-style-type: none"> <li>• <b>Adult Birds:</b> <ul style="list-style-type: none"> <li>○ Cere colour not relating to the sex of the bird, i.e. hormonal change.</li> <li>○ Both primary tail feathers missing or neither below the secondary tail feathers</li> <li>○ Missing Primary Flight Feathers (refer Ideal Topography) <ul style="list-style-type: none"> <li>- when three or more outside visual flight feathers are missing from one wing</li> <li>- when two outside visual flight feathers are missing on both wings</li> </ul> </li> </ul> </li> <li>• <b>Broken Nest Feather:</b> <ul style="list-style-type: none"> <li>○ Disqualification clauses as per adult birds apply plus, pin feathers in the cap, visible adult feathers in the cap, neck, body or wings, solid iris ring where present in the variety coupled with adult coloured cere.</li> </ul> </li> </ul> <p><b><u>Penalty</u></b></p> <ul style="list-style-type: none"> <li>• Presence of pin feathers in adult birds</li> <li>• Missing Primary Flight Feathers (refer Ideal Topography) <ul style="list-style-type: none"> <li>- when two outside visual flight feathers are missing in one wing</li> </ul> </li> </ul>

<p><b>Condition cont.</b></p>	<ul style="list-style-type: none"> <li>- when one outside visual flight is missing in both wings</li> <li>• Missing one primary tail feather</li> <li>• Broken feathers.</li> </ul> <p>The worse the condition the greater the penalty</p>
<p><b>Variety</b></p>	<p><b><u>Disqualification</u></b></p> <p><b>Birds entered in the wrong class:</b></p> <ul style="list-style-type: none"> <li>○ Includes birds showing characteristics other than those described in <i>The Standard</i> for the variety they represent</li> <li>○ Combination of Cinnamon with Clearwing and Greywing.</li> <li>○ Entries in the Dominant Pied Class with ground colour spot only on back of head or other part of the body</li> </ul> <p><b>Eyes:</b></p> <ul style="list-style-type: none"> <li>○ Varieties without a clearly visible iris ring where required in <i>The Standard</i></li> <li>○ Varieties with a visible iris ring where the absence of an iris ring is required in <i>The Standard</i></li> </ul> <p><b>Heavy Head Flecking:</b></p> <ul style="list-style-type: none"> <li>○ Intensity and distribution of melanin in the Frontal, Forehead or Crown equal to or greater than the example shown below. Borderline cases difficult to classify as heavy or light are to be very heavily penalised.</li> </ul> <div style="display: flex; justify-content: space-around; align-items: center;"> <div data-bbox="550 963 847 1360" data-label="Image"> </div> <div data-bbox="951 968 1391 1360" data-label="Text" style="border: 1px solid black; padding: 5px;"> <p><b><u>Important Note</u></b> – <i>the utmost care must be taken when reproducing this image to ensure that both the image and depth of colour are reproduced accurately. This extends to enlarging the image which can have the effect of distorting the intensity of colour.</i></p> </div> </div> <p><b>Colour:</b></p> <ul style="list-style-type: none"> <li>○ Golden Faced Blue in all variety combinations that display sea green or grey green body colour rather than visual shades of blue or grey.</li> </ul> <p><b><u>Penalty</u></b></p> <p><b>Birds of any variety or Colour with:</b></p> <ul style="list-style-type: none"> <li>○ Light Head Flecking – Intensity and distribution of melanin in the Frontal, Forehead or Crown lighter than the example listed under Disqualification above. Penalty to be based on the heavier the flecking the heavier the penalty. Borderline cases difficult to classify as heavy or light are to be very heavily penalised.</li> </ul>

<p><b>Variety (cont)</b></p>	<ul style="list-style-type: none"> <li>○ Incorrect coloured cheek patches, other than birds entered in the wrong class</li> <li>○ Ground colour spot on back of head or other part of the body other than as permitted in <i>The Standard</i></li> <li>○ Incorrect iris ring colour – not white</li> <li>○ Incorrect cere colour for the variety as described in <i>The Standard</i></li> <li>○ Cleft, shallow or narrow masks</li> <li>○ Missing (or extra) spots where <i>The Standard</i> requires six. Spots where <i>The Standard</i> requires none. Spots incorrectly presented as required in <i>The Standard</i></li> <li>○ Feather disturbances : <ul style="list-style-type: none"> <li>- ruffle in neck or chest area</li> <li>- feathers on the feet</li> </ul> </li> <li>○ Wing colour and/or markings not as described in <i>The Standard</i></li> <li>○ Long flighted and/or heavy secondary flight feather characteristics</li> <li>○ Incorrect tail feather or tail quill colour within the parameters of the variety other than the disqualifiable characteristics</li> <li>○ Length of primary tail feathers not in proportion to the bird</li> <li>○ Dropped Tail</li> <li>○ Nipped Neck</li> <li>○ Poor Backline</li> <li>○ Poor Wing Carriage</li> </ul> <p><b>Departure from varietal features as set out in <i>The Standard</i></b></p> <ul style="list-style-type: none"> <li>○ Red eyed self colours with markings on the head, back of neck and wings - the heavier the markings, the heavier the penalty</li> <li>○ Clearwings that do not have clear &amp; pure ground colour on wings with absence of markings as described in <i>The Standard</i> - the heavier the markings the greater the penalty</li> <li>○ Greywings that have body colour and wing markings varying from that required in <i>The Standard</i> - the greater the departure the greater the penalty</li> <li>○ Self coloured birds, Spangle Double Factor and Lacewings with body colour suffusion</li> <li>○ Opalines not showing a clear ‘V’ effect in mantle or with inadequate wing markings</li> <li>○ Opalines with markings at the back of the head and neck</li> <li>○ Apart from Opalines, birds showing body colour on wings, back or neck</li> <li>○ Dominant PIEDS showing incorrect markings as defined in <i>The Standard</i> for that variety of Pied.</li> <li>○ Recessive PIEDS with wing markings greater or less than that as required in <i>The Standard</i> - the greater the departure the greater the penalty</li> <li>○ Crested – where a bird has an incomplete, damaged or untidy crest, multiple crests, crest off centre or has a crest or feather disturbance outside of the areas allowed for in <i>The Standard</i>. Any detectable trimming refer Disqualification section.</li> </ul>
------------------------------	---

<p><b>Variety (cont)</b></p>	<ul style="list-style-type: none"> <li>○ Dilutes that have body colour and wing markings greater or less than that required in <i>The Standard</i> – the greater the departure the greater the penalty.</li> <li>○ Spangles with the absence of correct throat spots or lack of definition of wing markings.</li> <li>○ Yellow Face colours and variety combinations that display white ground colour are to be penalised if the spillage of yellow from the mask to the body is more than minimal. The greater the spillage colour deviates from the normal the greater the penalty.</li> <li>○ Golden Face Blue in all variety combinations where spillage of yellow from the mask to the body is more than minimal, affecting the quality of the blue or grey colour as seen in the Blue Series. The greater the yellow suffusion the greater the penalty.</li> </ul>
<p><b>Inappropriate or Illegal act by an exhibitor or team carer/s.</b>  <b>Also refer Format &amp; Rules for the ANBC Annual Championship Shows</b></p>	<p><b><u>Disqualification</u></b></p> <ul style="list-style-type: none"> <li>● Any evidence of trimming (other than spots) or of dying or bleaching of feathers.</li> <li>● Any practice that is deemed to be unfair including the tampering with rings.</li> <li>● Double ringing, be it plastic or metal.</li> <li>● Rings other than the correct coloured ring marked with the year &amp; ANBC Secretary's nominated symbol.</li> </ul>

## **SPECIFICATION OF *THE STANDARD* SHOWCAGE**

**FOR THE AUSTRALIAN NATIONAL BUDGERIGAR COUNCIL (Inc) AS AMENDED –  
DECEMBER 2003**

**REVISION "D" DECEMBER 2003**

### **PREAMBLE**

This specification and accompanying drawings is a performance document and compliance with the written word and/or drawings does not of itself mean acceptance of any cage. Acceptance or rejection of any cage shall be based on inspection by the rules of individual state requirements.

The primary objective of this specification and the accompanying drawings is that all show cages will be identical and indistinguishable from other standard show cages. The written description and drawings is an aid to achieve this objective.

The second objective of these documents is to ensure that standard cages have a useful life in excess of ten years, when used under normal circumstances and conditions.

Provided the materials and method of construction closely comply with the specification requirements such a life should be achieved with periodic repainting as necessary.

Copyright of the design contained in this specification and accompanying drawing is retained by the ANBC (Inc). Authority to reproduce this documentation in whole or in part must be obtained in writing from the Secretary of the ANBC (Inc).

### **WORKMANSHIP**

Perform all operations necessary in first class joiners work. Ensure finished work is true, straight and square. Dress all visible edges with sandpaper to 0.5mm radius. The dimensions of the completed cage shall be within the tolerances shown on the drawing. All dimensions are in millimetres.

### **PLYWOOD**

Plywood used for construction of the cage shall comply with Australian Standard AS2271-1979.

Plywood used shall be "A" type bond.

4mm thick plywood shall be 3 ply construction.

6mm and 9mm thick plywood shall be 5 ply construction.

Plywood finishes for both faces shall be either a B grade finish or shall be provided with a medium density overlay.

All joints between plywood shall be made using a high solids fast drying high grade general purpose PVA adhesive. Prior to application of adhesive plywood with a medium density overlay, if used, shall have the contact areas intentionally roughened.

All joints between plywood panels shall be nailed using 15mm long x 1.0mm dia. Brad head nails at the locations shown on the drawing.

## **DOOR**

The door shall be hinged at the top with a 38 x 27 cadmium plated cabinet series butt hinge. Each hinge leaf shall be double armed. The hinge shall be fixed to the door and cage by 4 - 6 x 1/4 self tapping zinc plated Pan/Phillips head screws.

The door shall be secured by a 30mm brass box hook fixed to the door with 1-6 x 1/4 head screw. The stop to the box hook shall also be 1-6x1/4 self tapping zinc plated Pan/Phillips head screw located as shown on the drawing. Additional security may be provided to the door by:

1. Attaching a brass canteen clip JW 1591-8 5 fixed at the position of one o'clock by a 1-6 x 1/4 self tapping zinc plated Pan/Phillips head screw. Pressure tightened to allow movement.
2. Attaching a brass canteen clip JW 1591-8 5 fixed at the position of three o'clock by a 1-6 x 1/4 self tapping zinc plated Pan/Phillips head screw. Pressure tightened so as not to allow movement.
3. Attaching a 75mm x 18mm strip of black self adhesive electrical tape placed horizontally over the brass box hook
4. Attaching any (or all) of the above.

## **PAINTING**

All timber surfaces and the door hinge and screws shall be painted. The door brass box hook, canteen clip and associated screws shall be unpainted.

Prepare surfaces so they are free from contaminants, make good surface and joint imperfections. Joints shall not be visible in the completed cage.

Paints shall be of prime quality conforming to the relevant Australian Standard Specification and Government Proved Certificate. All paint shall be supplied by a recognised nationally based paint manufacturer. Paints used shall be compatible with each other as determined by reference to manufacturers recommendations.

The interior of the cage, including the top of the bottom rail, shall be painted with acrylic based wood primer followed acrylic water based semi-gloss white.

The exterior of the cage shall be painted with acrylic based wood primer, followed by a full gloss enamel black or acrylic based gloss black.

Full gloss estapol (clear finish) coating to the exterior of the cage shall be permitted to protect the exterior surfaces.

## **HARDWARE**

Attached is an appendix which lists various components of the cage. This specification does not intend to nominate the source of supply. Manufacturers are however advised to consider the consequences of the method of acceptance of cages to this specification under the Preamble heading.

## WELDED WIRE FRONT

The wire used for fabrication of the cage front shall be 2.0mm and 2.5mm diameter standard bright hard drawn low carbon (C = 0.12%C) general purpose manufacturing wire.

The set down at welded intersections shall be approximately 10%. The welding procedure shall be sufficient to develop at least 100 MPa tension in either wire when tested in weld shear under a similar procedure to that set down in Appendix B of AS 13 04 -1984 Welded Wire Reinforcing Fabric for Concrete.

The welded wire front shall be powder coated and shall meet the following requirements.

The front shall be properly cleaned and dipped prior to the powder coating process to ensure longevity of the coating.

The significant surface shall be free from visible defects such as blisters, pits, roughness, cracks and shall be free of stain or discoloration.

The approved paint colour is -

**Colour:** Precious Silver Pearl Gloss. **Level:** Satin. **Brand:** Dulux.

**Line NO:** 272. **Shade NO:** 57225.

The front shall be secured in position by means of a hollow screw produced from a black finish Unbracko M4.0 x 16 long x 0.7 pitch socket head grub screw drilled out to produce a 2.5mm diameter hollow core to accommodate the central vertical wire of the welded wire front.

## DRINKER

A drinker manufactured to the dimensions shown on the drawing shall be installed immediately above the mid wire of the front between the fourth and fifth vertical wires from the left when the cage is viewed from the front. *The Standard Showcage* shall always be used with a drinker installed even in areas where drinkers are not required by legislation.

The welded wire front shall be secured in position by means of a hollow screw produced from a black finish Unbracko M4.0 x 16 long x 0.7 pitch socket head grub screw drilled out to produce a 2.5mm diameter hollow core to accommodate the central vertical wire of the welded wire front.

## PERCH

The perch will be of good quality 12mm dowel 149mm long with outer edges left square and positioned as described in diagrams ANBC1c and TC-1 to extend in line with the outer edge of the front board.

The perch will be fixed either with a 1mm diameter pin with 3mm extension, or, screwed with 1/No.6 x ¾ self tapping zinc plated, Pan/Phillips head screw.

NOTE 1: Refer to Standard Show Cage Drawing for dimensions and construction of 12mm perches.

NOTE 2: The ANBC recognises that some States and Zones had extensively attended change to the 16mm perch and accepts that should they see an economical advantage to retain these perches at local shows their decision to retain both dimension perches can be applied. If this is the case any 16mm perches must comply



to past dimensions being that the cutout is a horizontal cut of 6mm and a vertical cut of 4mm meeting the horizontal cut that removed a small block out of the bottom end of the perch. The vertical slot is 4mm deep to suit 2mm diameter wire front bar.

## **APPENDIX**

6mm Crezon faced plywood or Lake Pine.

4mm & 9mm exterior grade "A" type bond plywood.

30 brass box hook from Howard V. Parkes Fairfield Victoria.

6x1/4 self tapping zinc plated Pan/Phillips head screws by Spurway Cooke.

Canteen Clip (safety clip) JW 1591-85 from Howard V Parkes Fairfield Victoria

Drinkers from Pacemaker Plastics Moorabin Victoria.

3/16 BSW x 5/8 Unbracko grub screw

38 x 27 cadmium plated cabinet series butt hinge available from Warlan Pty. Ltd. South Australia.

[Type here]

**DRAWING - STANDARD SHOWCASE**

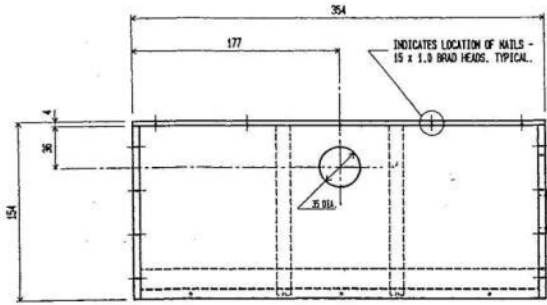

**PLAN VIEW**

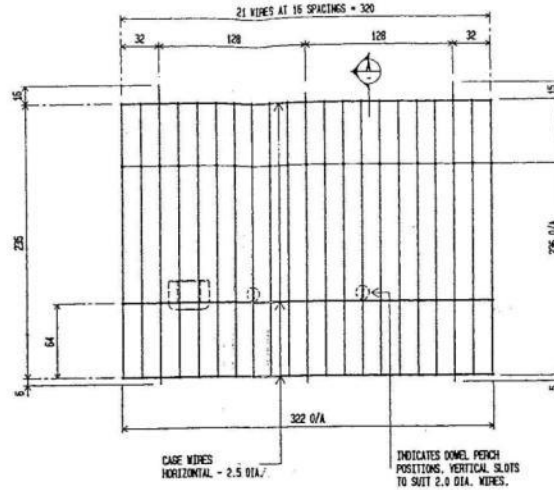

**ELEVATION - WIRE CAGING**  
NOTE: CASE WIRES - 2.0 DIA. / 2.5 DIA. TO BE CHROMIUM PLATED IN ACCORDANCE WITH SHOWCASE SPECIFICATION.

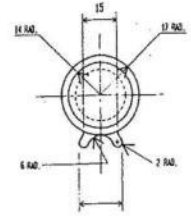
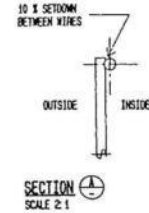

**PLAN - DRINKER**

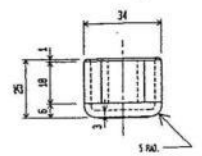

**ELEVATION - DRINKER**  
SCALE 1:1

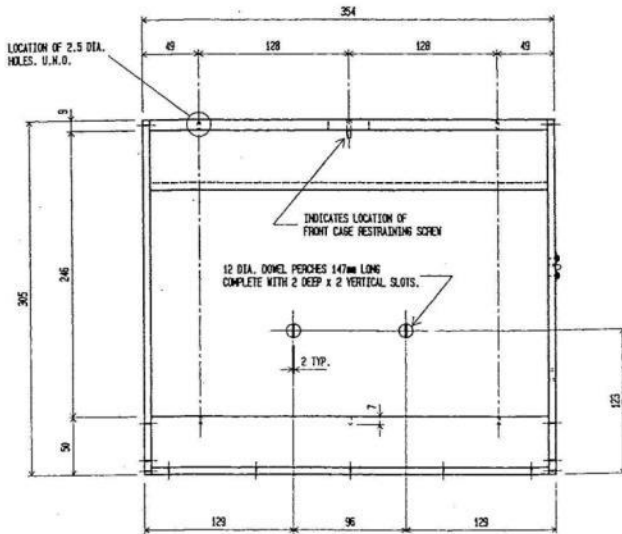

**FRONT ELEVATION**  
WIRE CAGING NOT SHOWN FOR CLARITY. REFER ELEVATION FOR WIRE CAGING DETAILS.

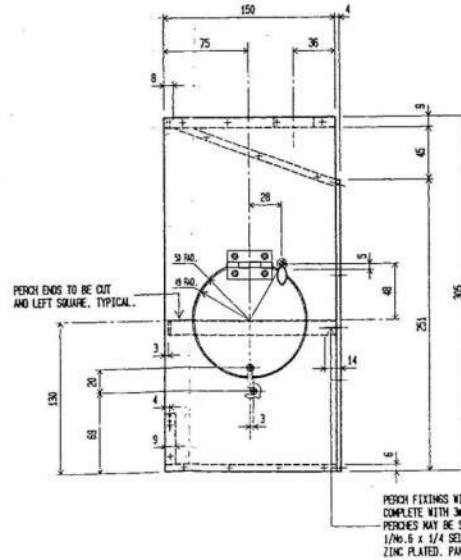

**END ELEVATION**

PROVIDE 4/No. 6 x 1/4 SELF TAPPING ZINC PLATED PAN/PHILLIPS HEADSCREWS, TYPICAL.

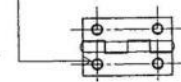

**40 x 25 CABINET SERIES BUTT HINGES**  
SCALE 1:1

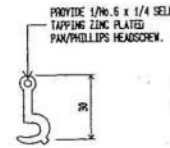

**30 BRASS BOX HOOK**  
SCALE 1:1

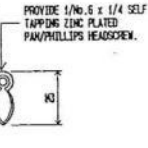

**BRASS CUTLERY CLIP**  
SCALE 1:1

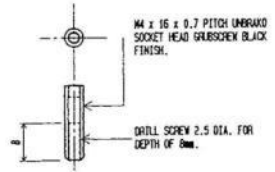

**FRONT RESTRAINING SCREW**  
SCALE 2:1

- NOTES**
1. DIMENSIONAL TOLERANCES:  
SIZE 100 OR LESS ± 1.0mm  
SIZE GREATER THAN 100 ± 2.0mm
  2. MATERIALS FOR CONSTRUCTION TO BE IN ACCORDANCE WITH SHOWCASE SPECIFICATION.
  3. FINISHES:  
WIRE FRONT - BRIGHT CHROME (refer spec.)  
DOOR CATCH - BRASS FINISH  
SAFETY CATCH - BRASS FINISHES  
DOOR STOP - CADMIUM FINISH  
DOOR HINGE & SCREWS - GLOSS BLACK
- PLYWOOD CASE INTERIOR INCLUDING TOP OF BOTTOM RAIL - ACRYLIC GLOSS WHITE  
EXTERIOR - GLOSS BLACK
- REFER SHOWCASE SPECIFICATION FOR PAINTING REQUIREMENTS.

COPIES OF DESIGN DRAWING HEREON TO BE RETURNED BY CUSTOMER WITHIN 30 DAYS OF SIGNATURE. AUTHORITY IS REQUIRED FOR AN AMENDMENT.

C	CLIP ASSEMBLY/PERMANENT	1/50	05.06.95
B	PERMANENT	1/50	04.06.95
A	DRAWING L.D.M. PERCH/DOOR/DRINKER	1/1	14.02.93

Drawn: R.A.  
Date: AUGUST 1992  
Scale: 1:2 U.M.O.  
Checked: [Signature]  
Approved: [Signature]  
Project No. ANBC1c

[Type here]

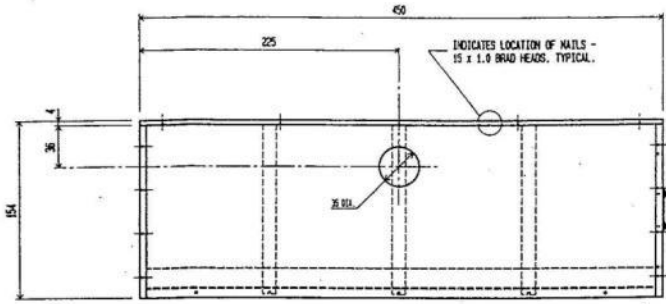

PLAN VIEW

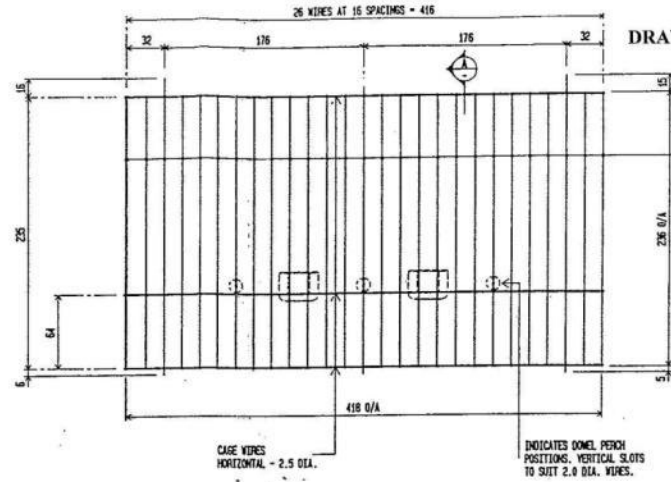

ELEVATION - WIRE CAGING

NOTE: CAGE WIRES - 2.0 DIA. / 2.5 DIA. TO BE CHROMIUM PLATED IN ACCORDANCE WITH SHOWCASE SPECIFICATION.

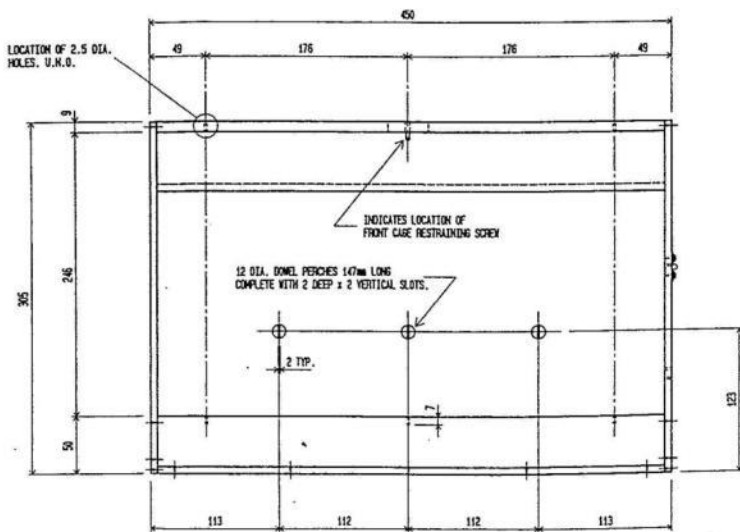
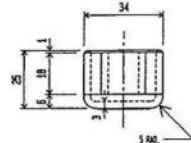
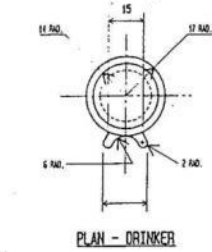

FRONT ELEVATION

WIRE CAGING NOT SHOWN FOR CLARITY. REFER ELEVATION FOR WIRE CAGING DETAILS.

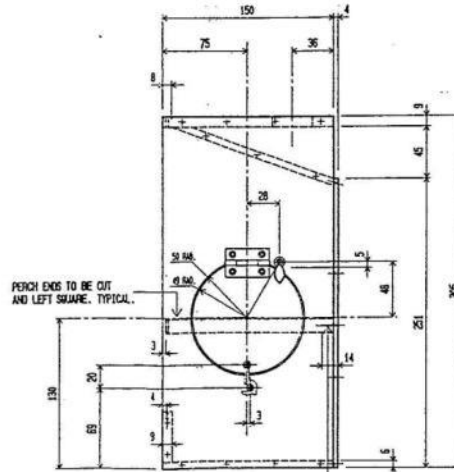

END ELEVATION

PROVIDE 4/No. 6 x 1/4 SELF TAPPING ZINC PLATED PAN/PHILLIPS HEADSCREWS, TYPICAL.

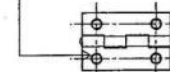

PROVIDE 1/No. 6 x 1/4 SELF TAPPING ZINC PLATED PAN/PHILLIPS HEADSCREW.

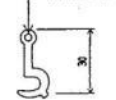

PROVIDE 1/No. 6 x 1/4 SELF TAPPING ZINC PLATED PAN/PHILLIPS HEADSCREW.



PERCH FIXINGS WITH 1 DIA. PIN COMPLETE WITH 3mm EXTENSION. PERCHES MAY BE SCREWED WITH 1/No. 6 x 3/4 SELF TAPPING ZINC PLATED PAN/PHILLIPS HEADSCREW.

M4 x 16 x 0.7 PITCH UNBRASS SOCKET HEAD GRUBSCREW BLACK FINISH.

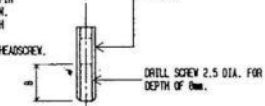

- NOTES
1. DIMENSIONAL TOLERANCES:  
SIZE 100 OR LESS ± 1.0mm  
SIZE GREATER THAN 100 ± 2.0mm
  2. MATERIALS FOR CONSTRUCTION TO BE IN ACCORDANCE WITH SHOWCASE SPECIFICATION.
  3. FINISHES:  
WIRE FRONT - BRIGHT CHROME (refer spec.)  
DOOR CATCH - BRASS FINISH  
DOOR STOP - CHROME FINISH  
SAFETY CATCH - BRASS FINISH  
DOOR HEDGE & SCREWS - GLOSS BLACK

PLYWOOD CAGE INTERIOR INCLUDING TOP OF BOTTOM RAIL - ACRYLIC GLOSS WHITE  
EXTERIOR - GLOSS BLACK

REFER SHOWCASE SPECIFICATION FOR PAINTING REQUIREMENTS.

Rev	By	Date

11114 STANDARD TEAM CAGE  
INCORPORATES FEATURES FROM AWC STANDARD SHOWCASE

Drawn: R.A.  
Date: MAY 1995  
Scale: 1:2 U.N.D.  
Checked: \_\_\_\_\_  
Approved: \_\_\_\_\_  
Project No. \_\_\_\_\_  
Dwg No. \_\_\_\_\_  
TC-1